

Roller Shade (Chain Operated Clutch)

Installation Instructions

Please follow these Installation Instructions

You will need a pencil, tape measure, drill, screwdriver, pliers, and appropriate fasteners.

Step 1: Choose the Correct Fastener

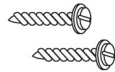

1 1/2" #8 Hex Head
Wood Screws (Included)

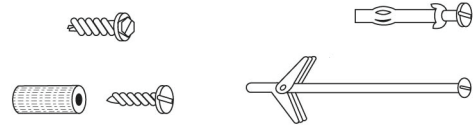

Alternative fasteners should be used for aluminum or
concrete installations
(Not Included with Blinds)

Step 2: Mark the Bracket Locations

Position the installation brackets at each end of the roller shade. In the diagram to the left, bracket positions are illustrated for a shade with a chain control on the right hand side. For a shade with a chain control on the left hand side, the brackets should be at the opposite end. Brackets may be mounted to the wall, ceiling, or inside of the window frame.

Critical Note: Installation brackets must be level to ensure that the fabric will roll up properly, allowing for smooth operation. Installation brackets must be placed such that the outer edge of the brackets are 1 1/4" wider than the fabric. Mark the brackets for mounting hole locations.

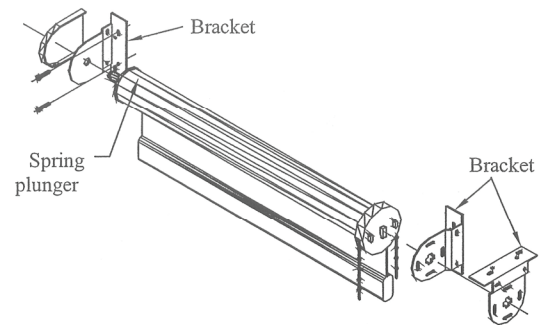

Step 3: Bracket & Shade Installation

Screw the brackets in place. For regular roll shades (fabric is rolled off the back of the roller), lift the shade up to the brackets with the fabric hanging closest to the window. For reverse roller shades (fabric is rolled off the front of the roller), lift the shade up to the brackets with the fabric hanging closest into the room.

Push the spring plunger (side opposite of the chain) into it the bracket as shown in the above diagram. Push the shade into the bracket, depressing the plunger. With the clutch hook pointing downward, place the hook into the vertical part of the "+" shaped hold in the bracket. Slightly pull down on the shade so that the clutch hook locks into place in the bracket.

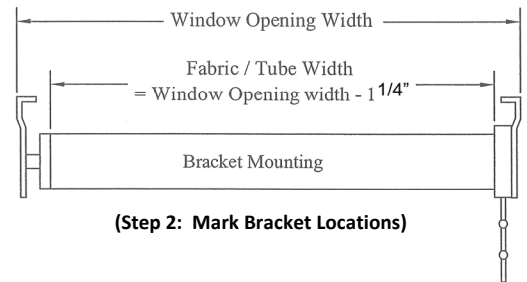

Step 4: Safety Clip Installation

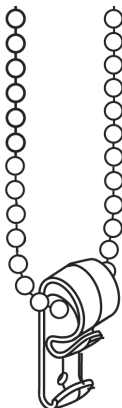

Safety tension clips are designed to minimize the hazards of strangulation and entanglement of small children by restricting access to the chain control. The safety tension clip is sent from the factory already attached to each chain control. Screw the safety tension clip into the wall or window frame with a screw.

Critical Note: The safety clip should be installed so that the bead chain and bead stop balls move smoothly through the opening of the clip. Removal of this device or failure to properly install it, can cause damage to the clutch lifting mechanism and will result in the voidance of the product's limited lifetime warranty.

(Step 3: Shade Installation)

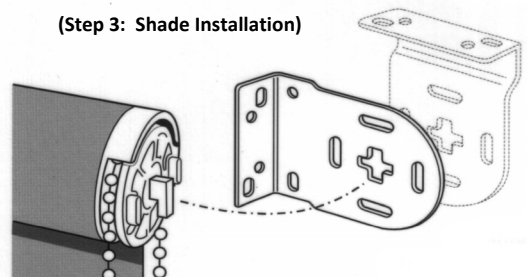

Roller Shade (Chain Operated Clutch)

Installation Instructions

Step 5: Set the Bottom Bead Stop

An additional metal bead stop is sent with each shade. This bead stop is used to prevent the shade from being lowered past its ordered drop (also known as the bottom limit). Lower the shade to the bottom of the window opening. Once the shade is at the bottommost point, the bead stop needs to be placed over the control chain.

For regular roll shades, place the bead stop in front of the clutch mechanism so that the chain cannot be pulled from the back any further. *For reverse roll shades*, place the bead stop in back of the clutch mechanism so that the chain cannot be pulled from the front any further. With a pair of pliers, squeeze the bead stop so that it cannot be removed.

Operating Instructions

It is strongly recommended to use two hands when operating (raising or lowering) the shade.

Lowering the Shade

Pull the *back chain* (closest to the window) down until the bead stop ball on the chain loop stops at the shade bracket and the shade hembar is approximately ½" above the window sill.

Raising the Shade

Pull the *front chain* (furthest from the window) down until the bead stop ball on the chain loops stops at the shade bracket and the shade hembar is at the top of the window. The shade hembar should hang just below the roller.

Preventing Chain Breakage and Clutch Damage

It is important to always use two hands when pulling on the bead chain. Pull the chain straight down. Do **NOT** under any circumstances pull the bead chain at an angle. Pulling the bead chain at an angle creates unnecessary pressure and strain on the bead chain and clutch. This action inhibits the intended operation of the clutch and can cause the shade to break.

When lowering the shade, do not let go of the bead chain as this action can cause the shade to lower quickly causing harm to the clutch or bead chain breakage. Allowing the bead chain to glide through the operators hands with gentle pressure assists in controlling the speed at which the shade will lower or raise.

(The diagram at the right indicates a left side chain control with a regular roll shade)

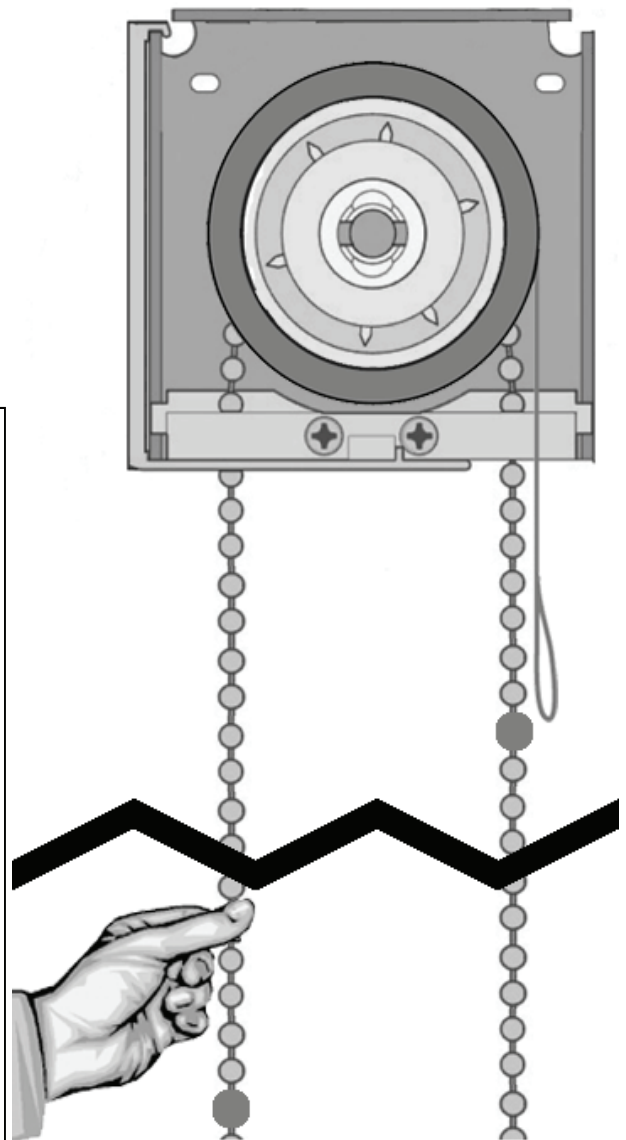

Roller Shade (Spring/Cordless)

Installation Instructions

Please follow these Installation Instructions

You will need a pencil, tape measure, drill, screwdriver, pliers, and appropriate fasteners.

Step 1: Choose the Correct Fastener

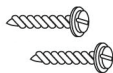

1 1/2" #8 Hex Head
Wood Screws (Included)

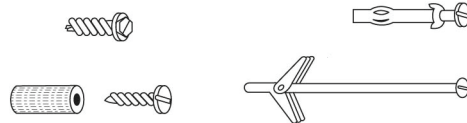

Alternative fasteners should be used for aluminum or
concrete installations
(Not Included with Blinds)

Step 2: Mark the Bracket Locations

Position the installation brackets at each end of the roller shade. In the diagram to the left, bracket positions are illustrated for a shade with a chain control on the right hand side. For a shade with a chain control on the left hand side, the brackets should be at the opposite end. Brackets may be mounted to the wall, ceiling, or inside of the window frame.

Critical Note: Installation brackets must be level to ensure that the fabric will roll up properly, allowing for smooth operation. Installation brackets must be placed such that the outer edge of the brackets are 1/4" wider than the fabric. Mark the brackets for mounting hole locations.

Step 3: Bracket & Shade Installation

Brackets are universal and can be fitted either to the left or right hand side, inside, wall, or ceiling mount. Screw the brackets in place. For regular roll shades (fabric is rolled off the back of the roller), lift the shade up to the brackets with the fabric hanging closest to the window. For reverse roller shades (fabric is rolled off the front of the roller), lift the shade up to the brackets with the fabric hanging closest into the room.

Secure the idler pin end into the bracket as shown in **Figure A**. Next, set the spring end into the open slot in the bracket as shown in **Figure B**.

Please note: Although the spring mechanisms are pre-tensioned at the factory, occasionally, they will uncoil during shipping. If this occurs, the shade will not raise or lower properly. A simple adjustment of the spring can correct this problem.

To Tighten The Spring Tension:

1. Pull the shade down approximately halfway.
2. Remove the roller shade from its brackets.
3. Roll up the shade by hand being careful to roll the shade evenly on the tube.
4. Replace the roller shade in its brackets.
5. Repeat these steps if necessary until you achieve the desired tension.

To Loosen The Spring Tension:

1. Roll up the shade.
2. Remove the roller shade from its brackets.
3. Unroll the shade approximately halfway by hand.
4. Replace the roller shade in its brackets.
5. Repeat these steps if necessary until you achieve the desired tension.

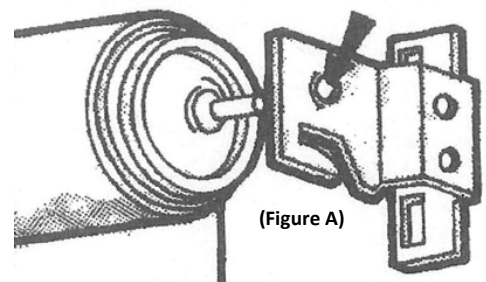

(Figure A)

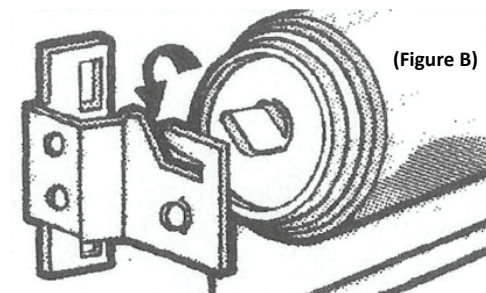

(Figure B)

