

Shutter Installation Instructions Deco Frame or L Frame Outside Mount 2 Sides Cafe Shutters

CONGRATULATIONS on purchasing the finest shutters in the market.

You can take pride that your purchase will enhance the function and beauty of your home.

INSTALLATION OVERVIEW

Getting Started

- Step 1: Assemble Frame
- Step 2: Attach the Panels
- Step 3: Secure the Light Block
- Step 4: Add the Finishing Touch



Installation Video

Scan the QR code with your smartphone to follow along with video instructions.



IMPORTANT: Do not mix panels or frames from other windows. Install one shutter at a time.

Tools needed for installing your shutter:

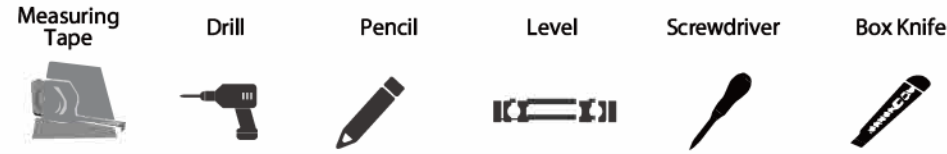

Getting Started

Remove the shutter from the package. Do not discard any of the packaging material until the shutter operates to your satisfaction. Check the diagram below to make sure you have the necessary parts.

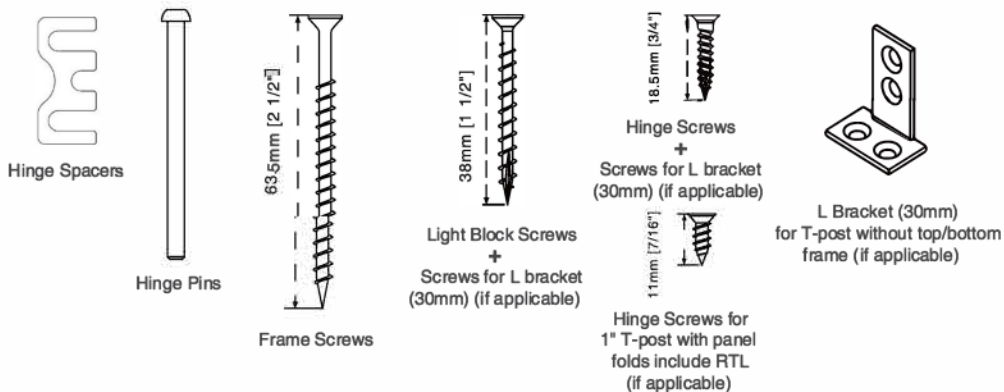
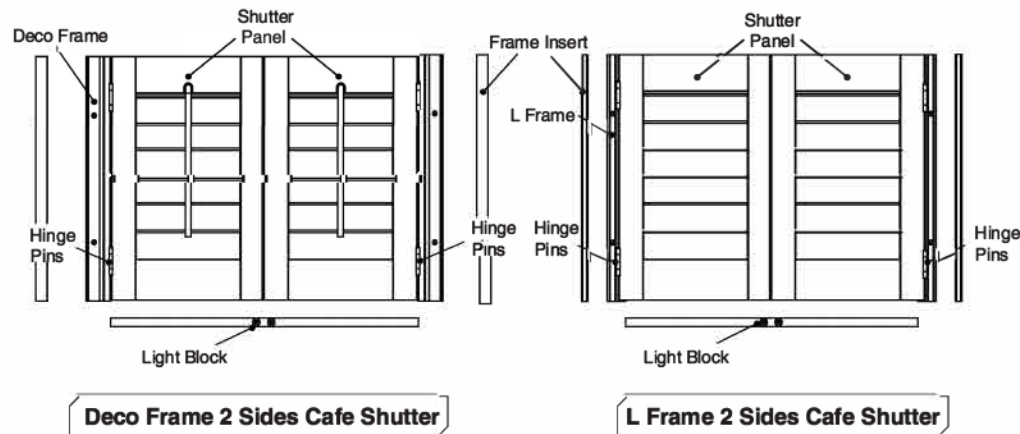

Step 1: Assemble Frame

- Carefully remove panels and frames from the packaging. Do not mix panels or frames from other windows. Frame pieces are labeled: left and right. To separate the frame inserts from the frames, gently lift the frame insert from one side of the frame. Then carefully slide the insert out of the frame.

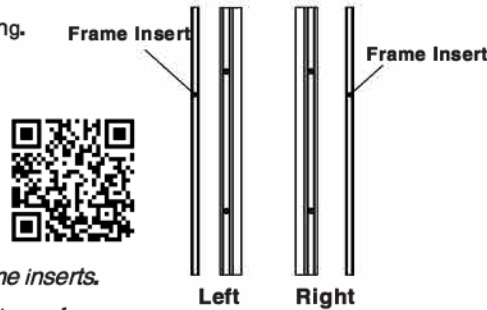

Scan the QR code to watch how to remove the frame inserts.

- On a soft, level surface (moving blankets or some type of pad works best) place the left and right frames opposite each other the approximate width of the window opening.

- If installing with T-post, use L bracket(30mm) to secure the T-post. Fasten the T-post with additional nails if necessary. If not installing with T-post, skip to the next step.

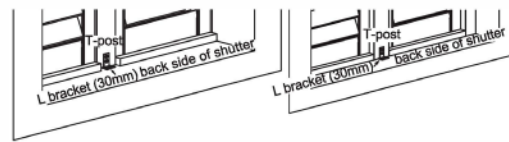

Step 2: Attach the Panels

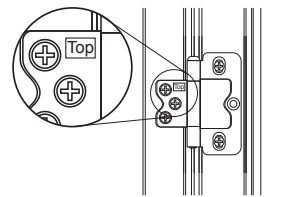

⚠ To ensure panels are installed correctly: Identify the top and bottom of the panel by locating the top label on the top hinge.

Single panel or hinged on 1 side only

- Align the panel with the hinged side of the frame. Secure the hinges with supplied hinge pins.

If you have bi-fold panels, start by securing this first panel to the frame. Then join the hinges of the panels labeled P1 and P2 and insert the hinge pins.

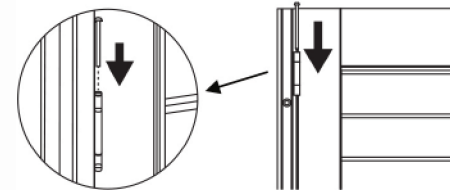

- Position the non-hinged frame against the shutter panel. There should be approximately 1/8" of space between the panel and frame from the top of the panel to the bottom.

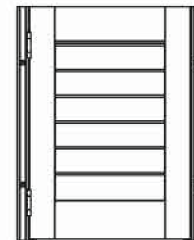

- With the frames and panel still lying on the floor, measure the distance from the outside edge of the left frame to the outside edge of the right frame. Record the distance.



- With the width measurement recorded in #3, center the tape measure on the window opening. With a pencil or painter's tape, mark the outside left and right frame measurements.



- Remove the hinge pins from the panel. Place the outside of the hinged frame against the recorded mark on the window opening. Using a level, ensure the frame is straight up and down. Temporarily secure the top and bottom of the frame with screws.

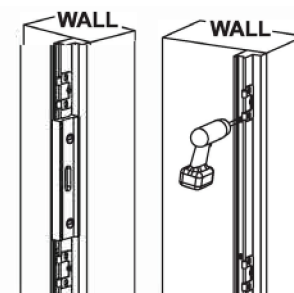

- Align the panel with the hinges of the installed frame and secure with hinge pins.

If you have bi-fold panels, start by securing this first panel to the frame. Then join the hinges of the panels labeled P1 and P2 and insert the hinge pins.

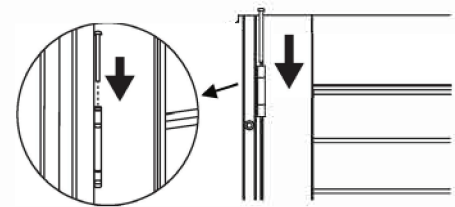

- Open & close panel and check for bottom clearance. Adjust hinges up or down as needed to gain or reduce bottom clearance.

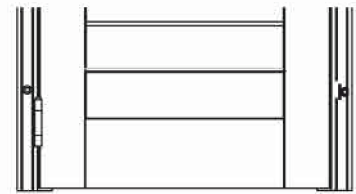

- Place remaining frame against mark recorded in #4. Temporarily secure with one screw.

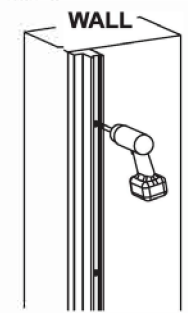

- Close the panel against the frame and check the spacing between the panel and the frame. Maintaining 1/8" of space, secure the bottom of the newly installed frame. Use shims as necessary.

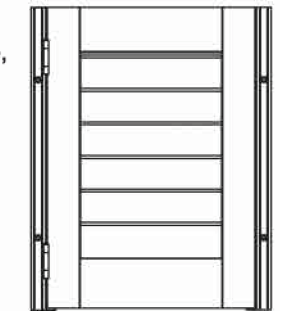

- Close the panel against the frame and check the spacing between the panel and the frame. Maintaining 1/8" of space, secure the bottom of the newly installed frame. Use shims as necessary. Once desired spacing has been achieved, secure frames with remaining screws.

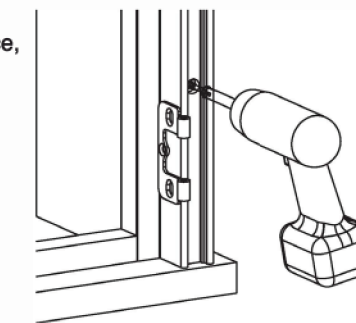

- Open & close panel and make any final adjustments. Use provided hinge spacers to adjust spacing if necessary.

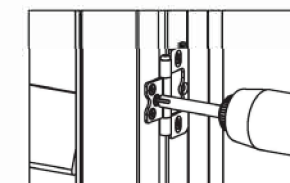

Loosen hinge screws on the panel

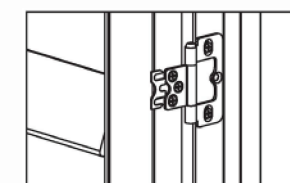

Insert spacer behind hinge, tighten screws



Spacer installed

- Fasten all the hinges by tightening the deadlock screw for each.

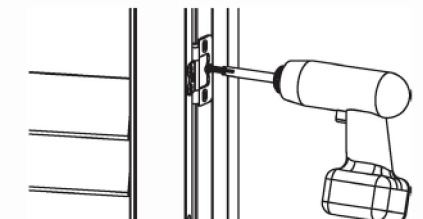
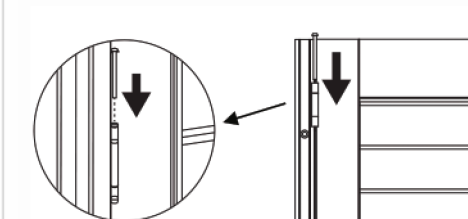

Multiple panels – hinged on both frames

1. Lay all panels into the both the left and right frame hinges and secure with hinge pins.

If you have bi-fold panels, after attaching the far left and/or far right panels to the frame, you will need to join the hinges of the panels labeled P1 and P2 and insert hinge pins. Repeat for panels labeled P3 and P4 if you have these. Proper order of panels from left to right is P1, P2, P3, P4.

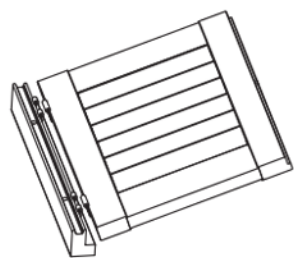

2. Close the left and right panel sections and check center spacing. Adjust frames by sliding them closer to or farther away from each other to achieve even spacing where the center panels come together. Make sure the panels/frames are level to each other by ensuring the panel tops and bottoms line up with each other.

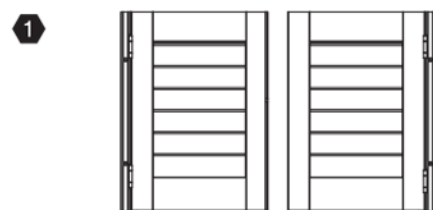

3. With the frames and panels still lying on the floor, measure the distance from the outside edge of the left frame to the outside edge of the right frame. Record the distance.



4. With the width measurement recorded in #3, center the tape measure on the window opening. With a pencil or painter's tape, mark the outside left and right frame measurements at the bottom and top heights of the frames.



5. Remove the hinge pins from the panels. Place the outside of the left frame against the recorded top & bottom marks on the window opening. Using a level, ensure the frame is straight up and down. Temporarily secure the top and bottom of the frame with screws.

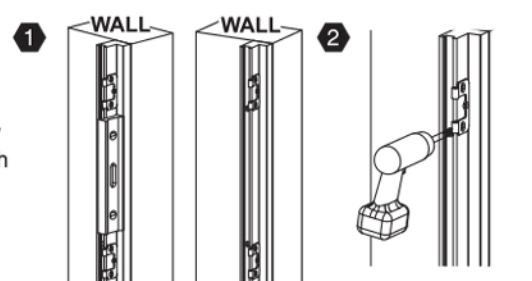

6. Repeat #5 for the right frame.

7. Align the panels with the hinges of the installed frames and secure with hinge pins.

If you have bi-fold panels, after attaching the far left and/or far right panels to the frame, you will need to join the hinges of the panels labeled P1 and P2 and insert hinge pins. Repeat for panels labeled P3 and P4 if you have these. Proper order of panels from left to right is P1, P2, P3, P4.

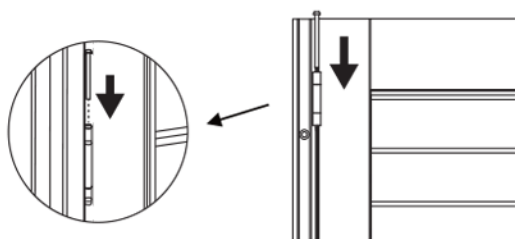

8. Close the panels against each other. Check the spacing between the panels, and ensure the panel tops line up.

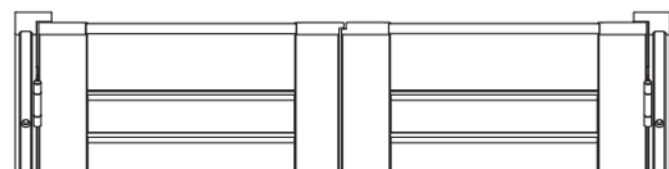

9. Once desired spacing has been achieved, secure frames with remaining screws.



10. Open & close panels and make any final adjustments. Use provided hinge spacers to adjust spacing if necessary. Panel heights can be adjusted by moving hinges up or down.

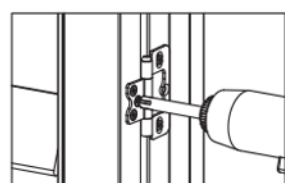

Loosen hinge screws on the panel

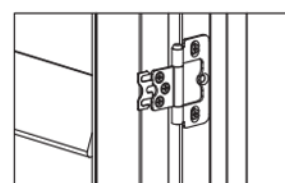

Insert spacer behind hinge, tighten screws

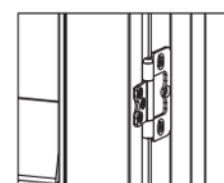

Spacer installed

11. Fasten all the hinges by tightening the deadlock screw for each.

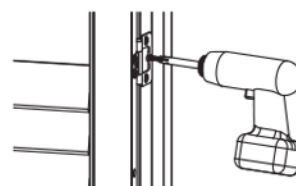

Step 3: Secure the Light Block

1. Open shutter panels and position the light block on the window sill. The front of the light block should be flush with the front of the left and right frames.
2. Once aligned properly, secure the light block with the light block screws provided through each pre-drilled hole.

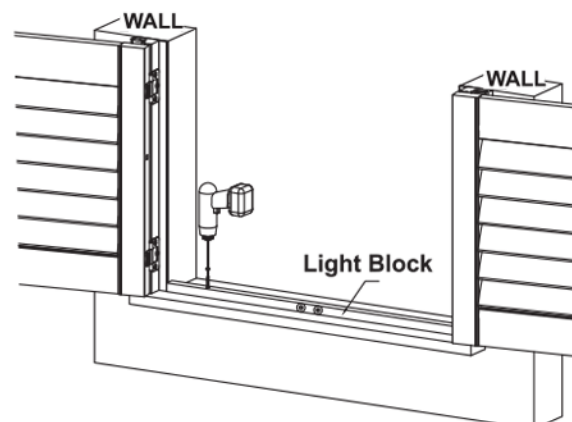

Step 4: Add the Finishing Touch

IMPORTANT: Check shutter operation and alignment before installing frame inserts, as frame inserts can NOT be removed once they are snapped into place.

Match each frame insert with the corresponding side of the frame: Left to Left, Right to Right.

Snap the frame inserts into place (OR remove double-sided foam tape and put the frame insert into place).

This will cover screws and provide a finished look.

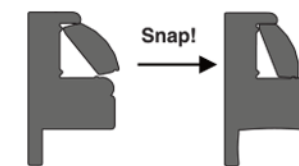

Snap!

Double-sided foam tape for wood frame only: Remove double-sided foam tape and put the frame insert into place.

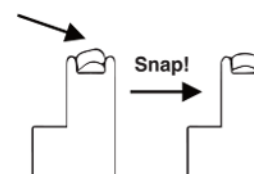
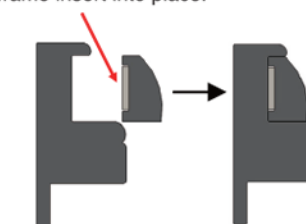

Snap!

Double-sided foam tape for wood frame only: remove double-sided foam tape and put the frame insert into place.

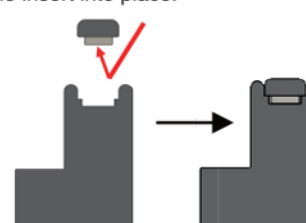

Maintain Your Shutter

Use a clean dry cloth, feather duster or vacuum with brush attachment to gently remove dust and debris. To ensure thorough cleaning, wipe the louvers in the open and closed positions. Do not immerse the product in water and do not use harsh chemicals to clean. This may cause discoloration and the wood to warp. Ultrasonic cleaning is not recommended. For best results on Composite Shutters, use a cotton cloth dampened with water. Polyester cloths tend to create static, which can attract dust.

Adjust the Tension System

If over a period of time the louvers on your shutters should loosen or not function properly, a built-in tension system can be adjusted. Simply open the panels fully and find the tension adjuster screw hole on the side of each panel. Use a screwdriver to gently turn the screw on each side of the panel to your desired resistance level. Repeat process for other panel(s) if necessary.

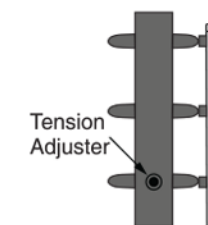

Lifetime Limited Warranty

All Acadia Living shutters have a lifetime limited warranty and will be free from defects in materials or workmanship for as long as the original retail purchaser owns the shutters, provided that such products were properly installed in residential dwelling; and such products were made or assembled exclusively from original materials and components. Any resale or other transfer of the product and/or materials voids this warranty.

For a complete copy of this warranty, please contact customer service by phone or email.

Customer Service

Phone: 855.667.6261

Email: Blinds.comSupport@NormanUSA.com

Step 5: Add the Finishing Touch

IMPORTANT: Check shutter operation and alignment before installing frame inserts, as frame inserts can NOT be removed once they are snapped into place.

Match each frame insert with the corresponding side of the frame: Left to Left, Top to Top, Right to Right, Bottom to Bottom (if the bottom frame has an insert).

Snap the frame inserts into place (OR remove double-sided foam tape and put the frame insert into place). This will cover screws and provide a finished look.

Double-sided foam tape for wood frame only: Remove double-sided foam tape and put the frame insert into place.

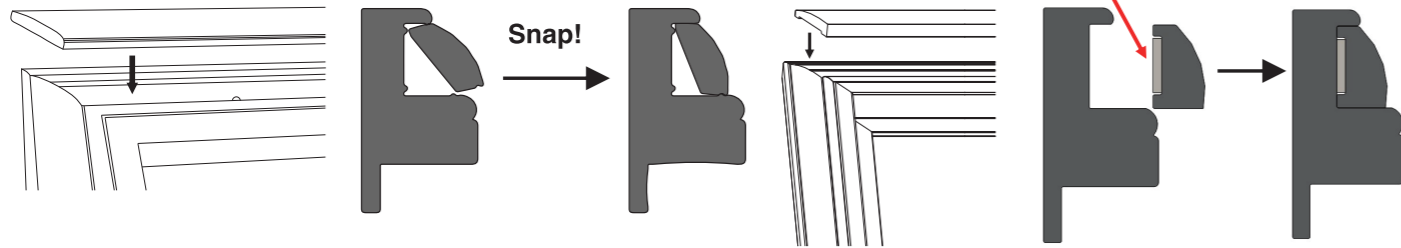

Maintain Your Shutters

Use a clean dry cloth, feather duster or vacuum with brush attachment to gently remove dust and debris. To ensure thorough cleaning, wipe the louvers in the open and closed positions.

Do not immerse the product in water and do not use harsh chemicals to clean. This may cause discoloration and the wood to warp. Ultrasonic cleaning is not recommended. For best results on Composite Shutters, use a cotton cloth dampened with water. Polyester cloths tend to create static, which can attract dust.

Adjust the Tension System

If over a period of time the louvers on your shutters should loosen or not function properly, a built-in tension system can be adjusted. Simply open the panels fully and find the tension adjuster screw hole on the side of each panel. Use a screwdriver to gently turn the screw on each side of the panel to your desired resistance level. Repeat process for other panel(s) if necessary.

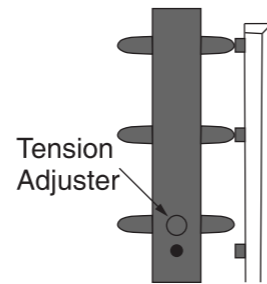

Lifetime Limited Warranty

All Acadia Living shutters have a lifetime limited warranty and will be free from defects in materials or workmanship for as long as the original retail purchaser owns the shutters, provided that such products were properly installed in residential dwelling; and such products were made or assembled exclusively from original materials and components. Any resale or other transfer of the product and/or materials voids this warranty.

For a complete copy of this warranty, please contact customer service by phone or email.

Customer Service

Phone: 855.667.6261

Email: Blinds.comSupport@NormanUSA.com

Version 37103-64900-A

ACADIA

LIVING™

Shutter Installation Instructions Deco Frame Outside Mount 4 Sides or 3 Sides with Bottom Sill Plate

CONGRATULATIONS on purchasing the finest shutters in the market.

You can take pride that your purchase will enhance the function and beauty of your home.

Installation Overview

- Getting Started
- Step 1: Assemble the Frame
- Step 2: Level the Frame
- Step 3: Secure the Frame
- Step 4: Attach the Panels
- Step 5: Add the Finishing Touch



Installation Video

Scan the QR code with your smartphone to follow along with video instructions.



IMPORTANT: Do not mix panels or frames from other windows. Install one shutter at a time.

Tools needed for installing your shutter:

Measuring Tape



Drill



Pencil



Level



Screwdriver



Box Knife



Getting Started

Remove the shutter from the package. Do not discard any of the packaging material until the shutter operates to your satisfaction. Check the diagram below to make sure you have the necessary parts.

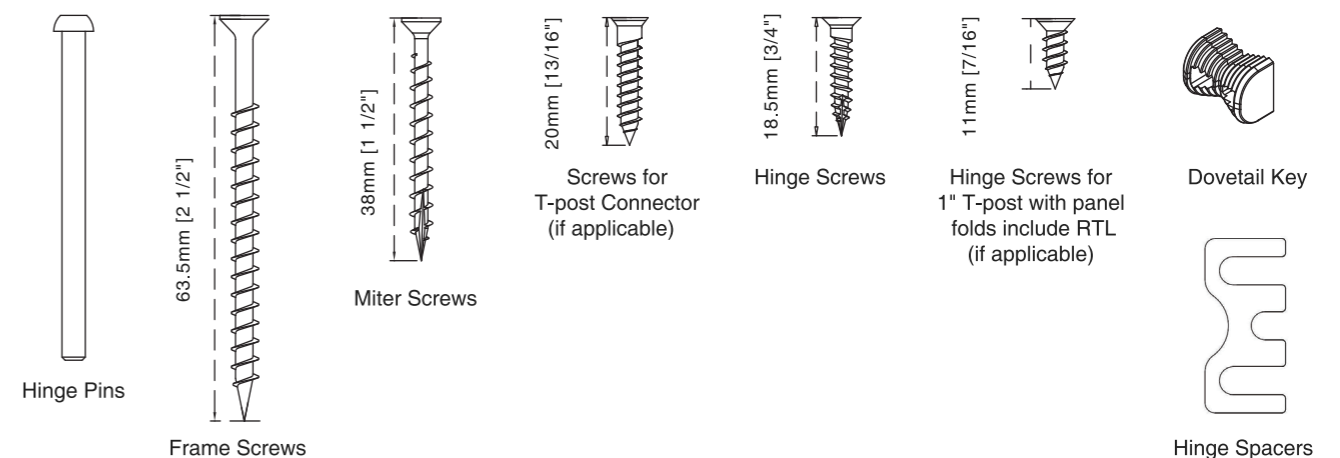
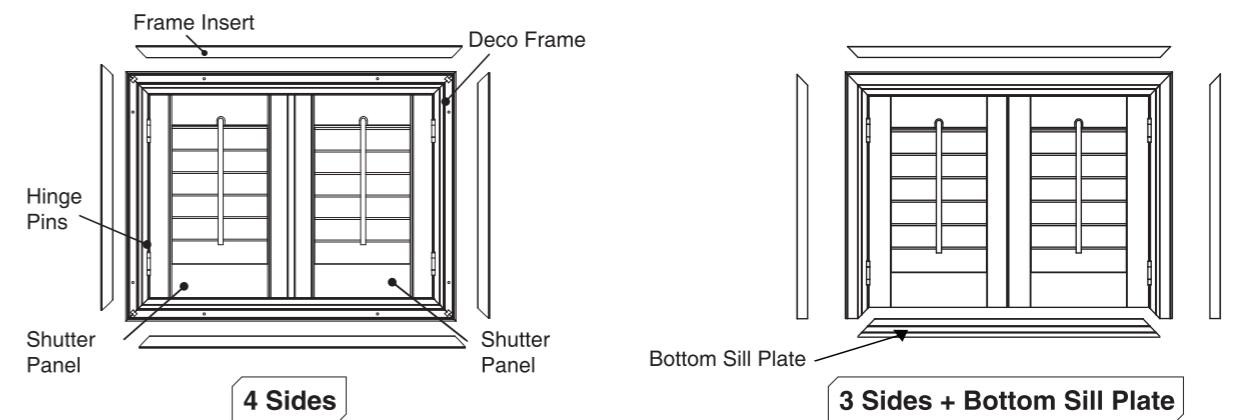

Step 1: Assemble the Frame

- Carefully remove panels and frames from the packaging. Do not mix panels or frames from other windows. Frame pieces are labeled: top, left, right, and bottom. To separate the frame inserts from the frames, gently lift the frame insert from one side of the frame. Then carefully slide the insert out of the frame.

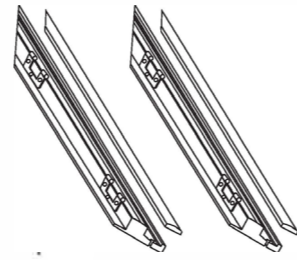

Scan the QR code to watch how to remove the frame inserts.



- Set all frames on a soft, level surface (moving blankets or some type of pad works best). Line up frame corners so that a slot for a Dovetail Key is formed.

※ If not installing with T-POST, skip to #5

- The top and bottom of the T-post are labeled. Locate and identify. Line up the pre-drilled holes with the top and bottom frame and secure with screws provided. Fasten the T-post with additional nails if necessary.

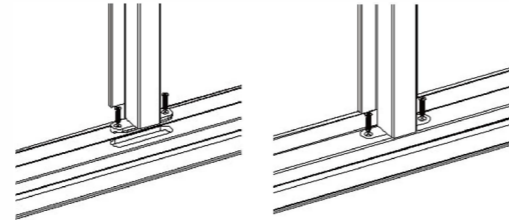

- ⚠ The T-post connector provides some wiggle room: make sure the T-post is at the center position at each end and secure with two screws. The T-post can also be adjusted when gaps between panels are not even.

- Insert a Dovetail Key into the slot at the back of the frame. Repeat this step for remaining corners to complete the frame assembly. Use a rubber mallet if necessary.

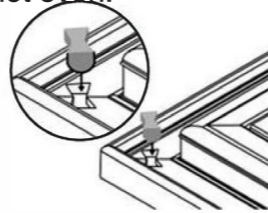

- ⚠ The Dovetail Key has a rounded side and a flat side. The rounded side should be inserted into the slot first. The flat side should be flush with the frame.

- Finish by securing the corner with the included miter screws via the pre-drilled hole.

- ⚠ Once secured properly, screw heads should not stick out from the frame.

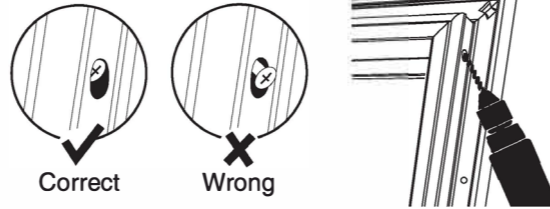

Step 2: Level the Frame

Position the assembled frame evenly around the window opening against the window edges. Then secure one screw into the upper left frame ONLY. Once done, level the frame on the window.

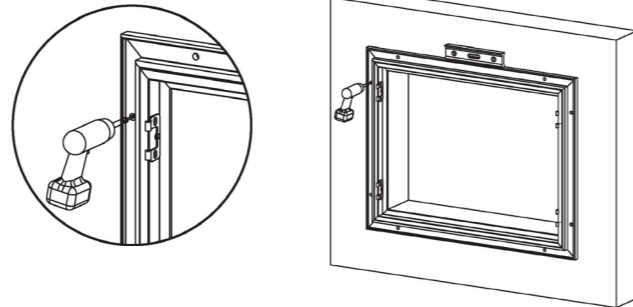

Step 3: Secure the Frame

To keep the frame level, tighten one screw into the upper right frame. The shutters will be fully secured in later steps.

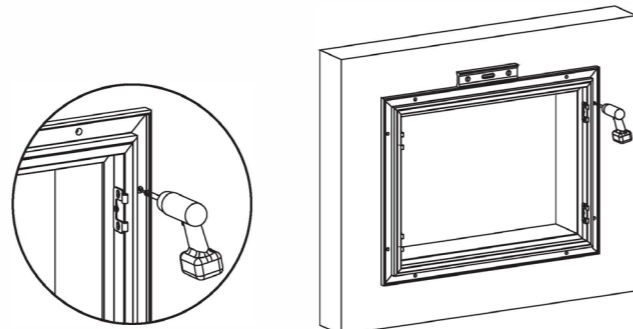

Version 37103-64900-A

Step 4: Attach the Panels

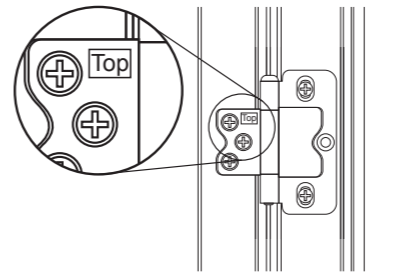

- ⚠ To ensure panels are installed correctly: Identify the top and bottom of the panel by locating the top label on the top hinge.

- Place the left shutter panel in the frame, align the hinges, and insert the hinge pin. Repeat for the right shutter panel.

If you have bi-fold panels, after attaching the far left and/or far right panels to the frame, you will need to join the hinges of the panels labeled P1 and P2 and insert hinge pins. Repeat for panels labeled P3 and P4 if you have these. Proper order of panels from left to right is P1, P2, P3, P4.

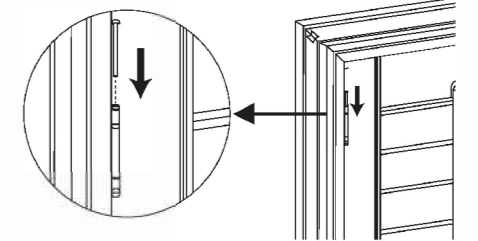

- If panel hinges are not aligned with frame hinges properly, then frame hinges can be adjusted.

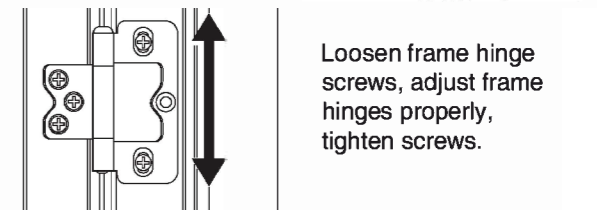

Loosen frame hinge screws, adjust frame hinges properly, tighten screws.

- Please check the gap between panel and frame at the top and bottom. The gap should be even; if not, then shift frame left to right until the gap is even.

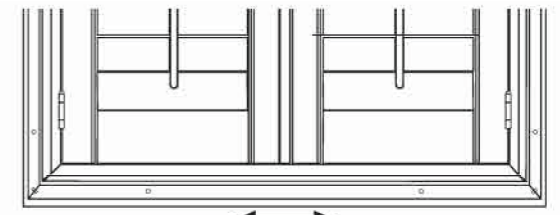

- Once even, secure a screw at the bottom of the left frame and right frame.

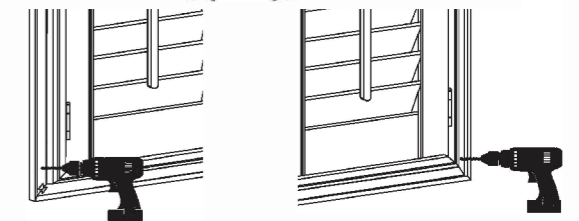

- Check gap between panels and adjust accordingly with hinge spacers provided if needed.

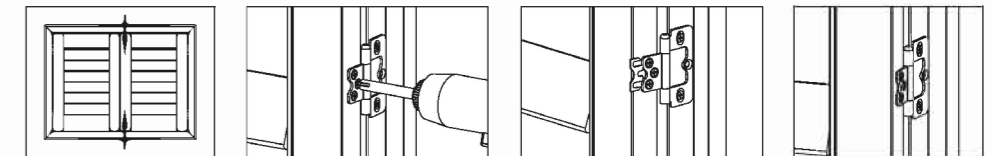

Loosen hinge screws on the panel

Insert spacer behind hinge, tighten screws

Spacer installed

- Open and close the panels to make sure they operate properly. Then secure the frame by tightening the rest of the screws into the pre-drilled holes. If bottom frame is a sill plate, fasten the bottom sill plate with additional nails if necessary.

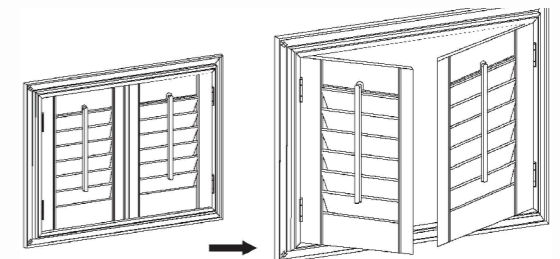

- Fasten all the hinges by tightening the deadlock screw for each.

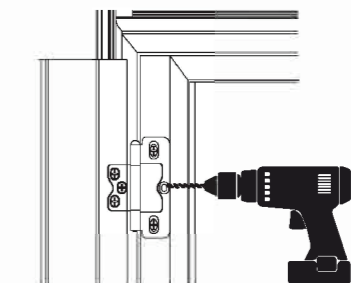

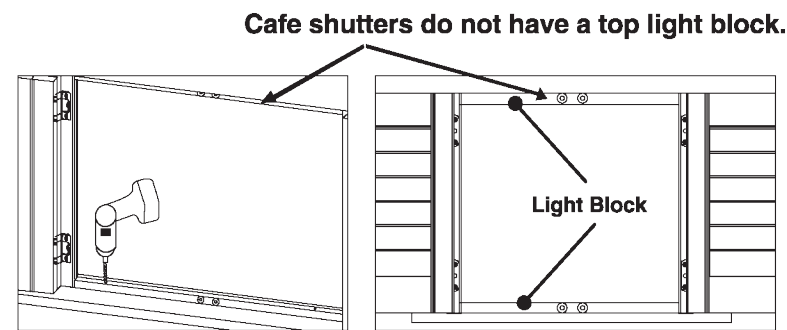

Step 5: Add the Finishing Touch

IMPORTANT: Check shutter operation and alignment before installing frame inserts as frame inserts can NOT be removed once they are snapped into place.

1. Match each frame insert with the corresponding side of the shutter frame: Left to Left and Right to Right. Snap the frame insert into place (OR remove double-sided foam tape and put the frame insert into place). This will cover screws and provide a finished look.

Tip: A rubber mallet can be used to help install frame inserts.

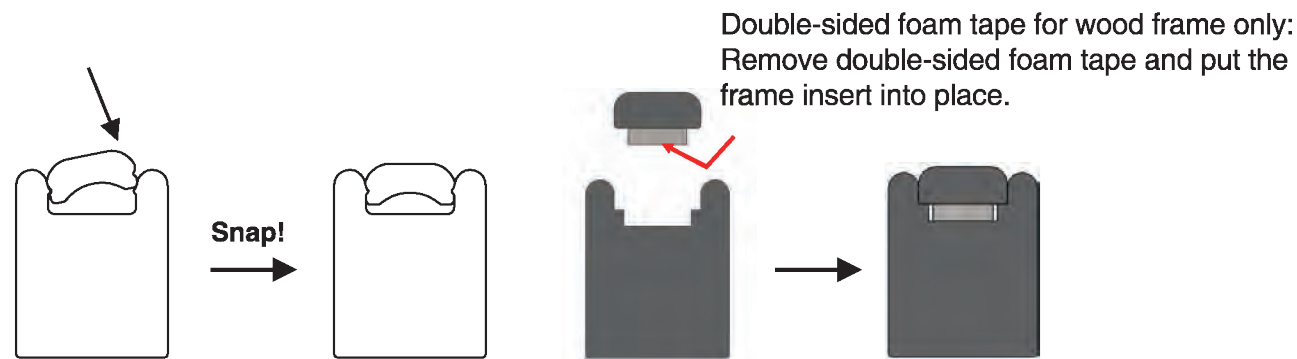

Maintain Your Shutter

Use a clean dry cloth, feather duster or vacuum with brush attachment to gently remove dust and debris. To ensure thorough cleaning, wipe the louvers in the open and closed positions. Do not immerse the product in water and do not use harsh chemicals to clean. This may cause discoloration and the wood to warp. Ultrasonic cleaning is not recommended. For best results on Composite Shutters, use a cotton cloth dampened with water. Polyester cloths tend to create static, which can attract dust.

Adjust the Tension System

If over a period of time the louvers on your shutters should loosen or not function properly, a built-in tension system can be adjusted. Simply open the panels fully and find the tension adjuster screw hole on the side of each panel. Use a screwdriver to gently turn the screw on each side of the panel to your desired resistance level. Repeat process for other panel(s) if necessary.

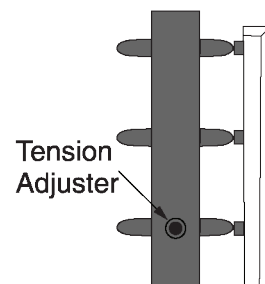

Lifetime Limited Warranty

All Acadia Living shutters have a lifetime limited warranty and will be free from defects in materials or workmanship for as long as the original retail purchaser owns the shutters, provided that such products were properly installed in residential dwelling; and such products were made or assembled exclusively from original materials and components. Any resale or other transfer of the product and/or materials voids this warranty.

For a complete copy of this warranty, please contact customer service by phone or email.

Customer Service

Phone: 855.667.6261

Email: Blinds.comSupport@NormanUSA.com

ACADIA

LIVING™

Shutter Installation Instructions

Hang Strip Inside Mount (Behind the Panel) 2 Sides

CONGRATULATIONS on purchasing the finest shutters in the market.

You can take pride that your purchase will enhance the function and beauty of your home.

INSTALLATION OVERVIEW

- Getting Started
- Step 1: Attach Hang Strip/Frame
- Step 2: Attach the Panels
- Step 3: Make Adjustments
- Step 4: Secure the Light Block
- Step 5: Add the Finishing Touch



Installation Video

Scan the QR code with your smartphone to follow along with video instructions.



IMPORTANT: Do not mix panels or frames from other windows. Install one shutter at a time.

Tools needed for installing your shutter:

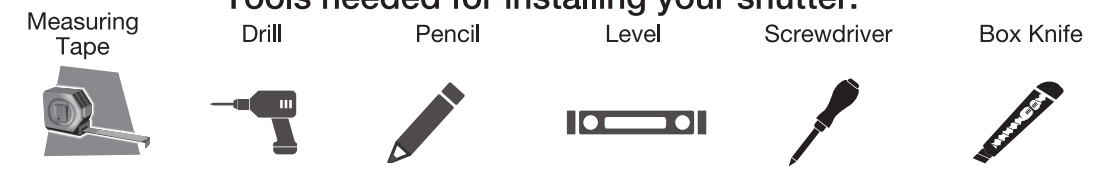

Getting Started

Remove the shutters from the package. Do not discard any of the packaging material until the shutters operate to your satisfaction. Check the diagram below to make sure you have the necessary parts.

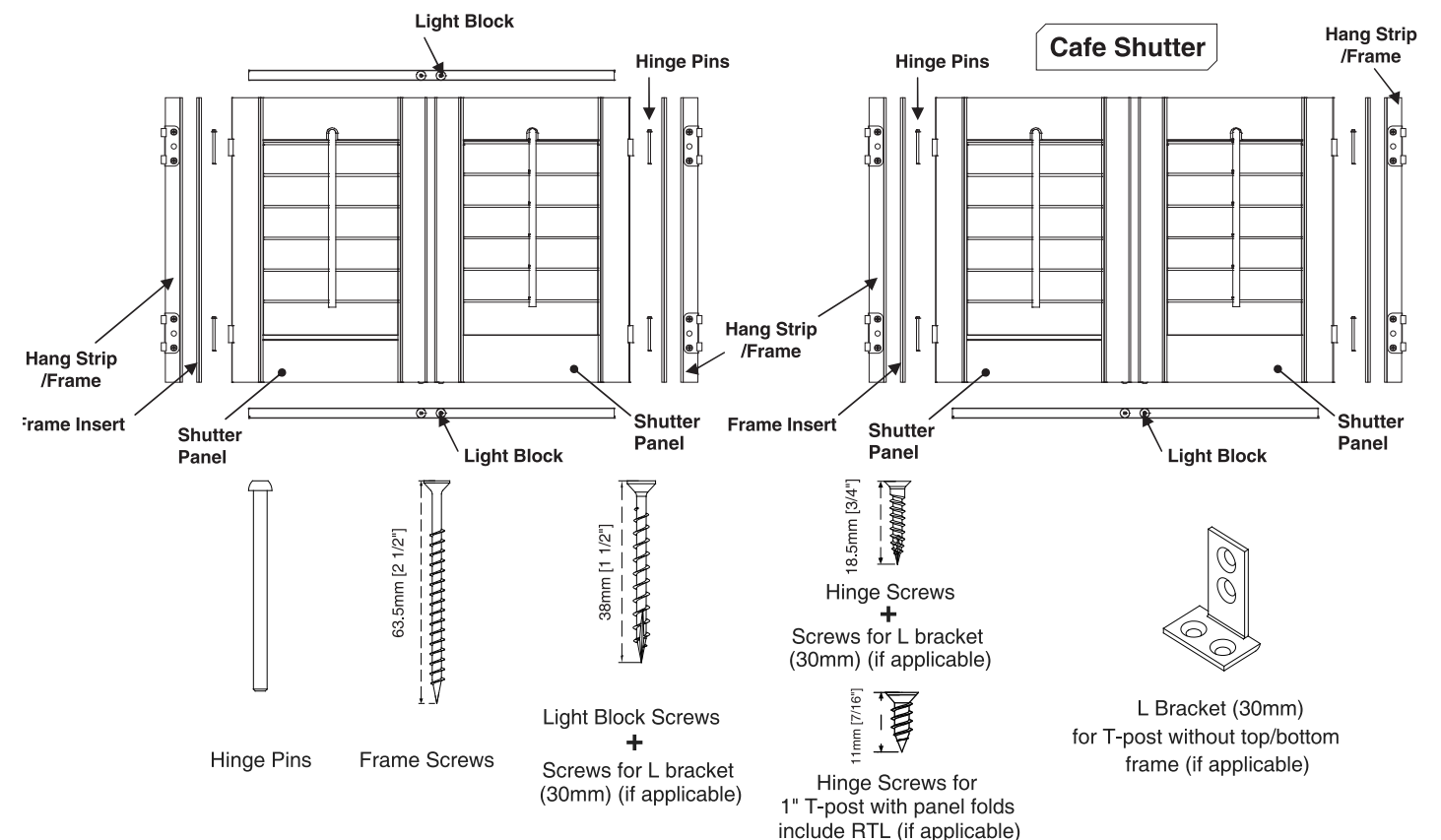

Step 1: Attach Hang Strip/Frame

- Carefully remove panels and frames from the packaging. Do not mix panels or frames from other windows. Frame pieces are labeled: left and right. To separate the frame inserts from the frames, gently lift the frame insert from one side of the frame. Then carefully slide the insert out of the frame.



Scan the QR code to watch how to remove the frame inserts.

- Place left hang strip along the inside left window jamb.

Tip: For flush panel installation, align the back side of the hinge barrel with the wall surface.

- Using a level, ensure the frame is straight up and down.

With the hang strip properly positioned in the opening, insert screw in top pre-drilled hole to attach the left frame to the jamb. Make sure the hinge barrel is positioned correctly before securing screw.

REPEAT for bottom pre-drilled hole. (Refer to tip above for flush panel installation.) Secure the frame with screws into the remaining pre-drilled holes.

- Repeat for the right frame.

- If installing with T-post, use L bracket (30mm) to secure the T-post.

Fasten the T-post with additional nails if necessary.

If not installing with T-post, skip to next step.

Step 2: Attach the Panels

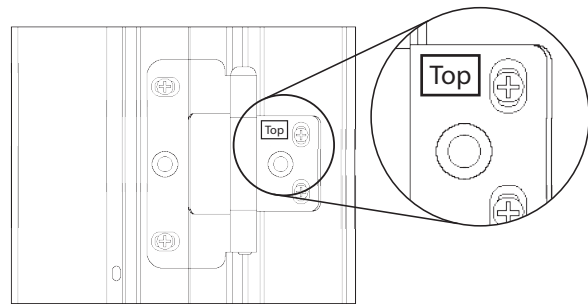

! To ensure panels are installed correctly: Identify the top and bottom of the panel by locating the top label on the top hinge.

- Before attaching the shutter panels, please make sure that the tilt bar notch is at the top of the window if the shutters operate with a tilt bar.

- With both hang strips installed, place the left shutter panel into the window opening and slide into position. Once the panel is aligned with frame hinges, insert hinge pins into hinges to secure the panel.

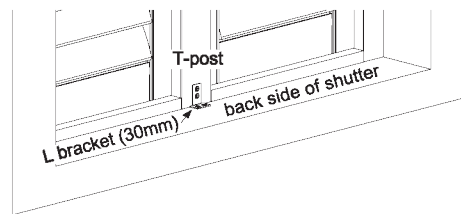
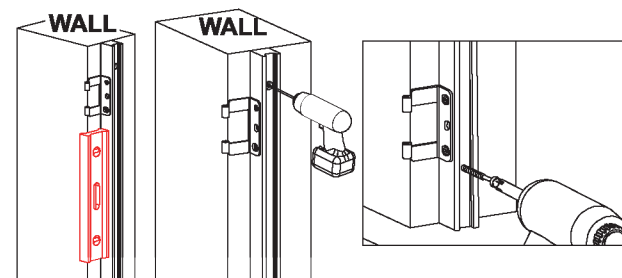
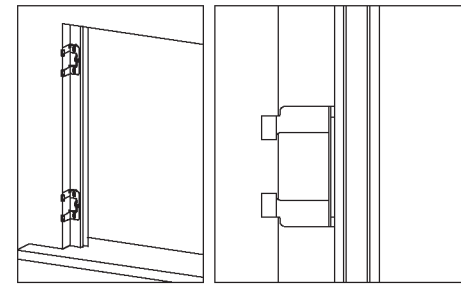
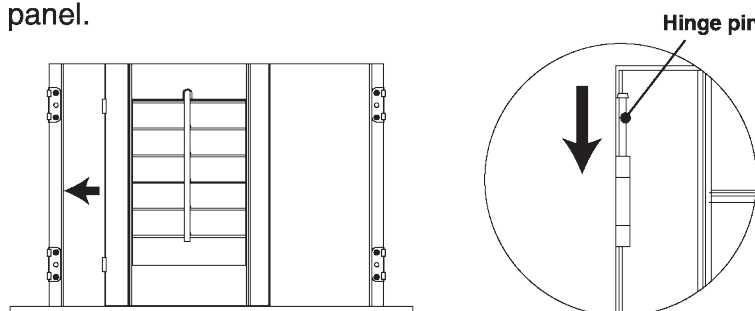

- With hinge pins installed, open the left panel. Place the right shutter panel into the window opening and slide into position. Once the panel is aligned with the frame hinges, insert hinge pins into hinges to secure the panel.

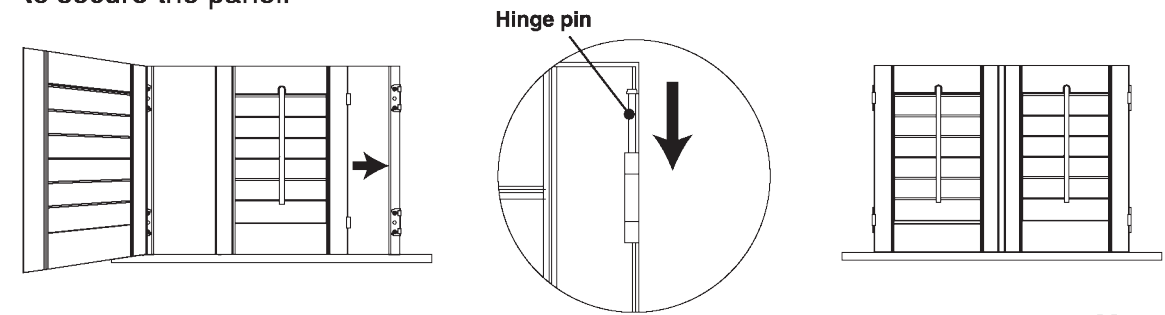

- If you have bi-fold panels, after attaching the far left and/or far right panels to the frame in the previous steps (1 & 2), you will need to join the hinges of the panels labeled P1 and P2 and insert hinge pins. Repeat for panels labeled P3 and P4 if you have these. Proper order of panels from left to right is P1, P2, P3, and P4.

Tip: If you should have any difficulty inserting the pin into the hinges, slightly loosen the hinge screws on the hang strip and move back or forth until the hinge pin slides into position. Then re-tighten the hinge screws on the hang strip.

Step 3: Make Adjustments

- Check gaps between panels and around the window opening; move the hinges left or right to adjust gap between panel/panel & panel/window opening in left and right. Slightly loosen the hinge screws on the panel and move the panel up or down to adjust a gap at the top and bottom.

! Re-tighten the screws after finishing the adjustment. Secure the deadlock screws (3/4") through the deadlock holes on hinges.

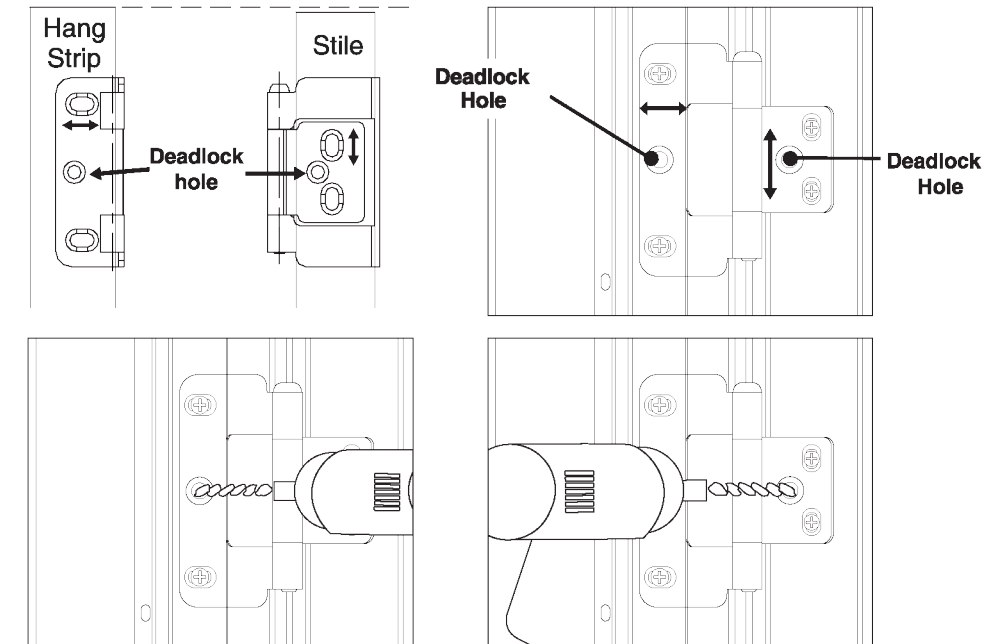

Step 4: Secure the Light Block

- Open shutter panels and position the light block evenly on the window sill. The front of the light block should be flush with the front of the left and right hang strips. Make sure magnets on panels will latch onto the magnet catches on the light block. Repeat for the top light block if there is a top light block.

- Once properly aligned, secure the top and/or bottom light blocks with the light block screws provided through each pre-drilled hole.

7. Fasten the deadlock screw for all hinges.

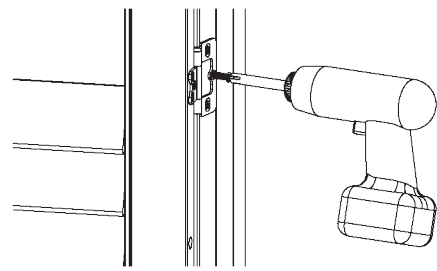

Step 5: Add the Finishing Touch

IMPORTANT: Check shutter operation and alignment before installing frame inserts, as frame inserts can NOT be removed once they are snapped into place.

Match each frame insert with the corresponding side of the frame: Left to Left, Top to Top, Right to Right, Bottom to Bottom.

Snap the frame inserts into place (OR remove double-sided foam tape and put the frame insert into place). This will cover screws and provide a finished look.

! A rubber mallet can be used to help install frame inserts.

Double-sided foam tape for wood frame only: Remove double-sided foam tape and put the frame insert into place.

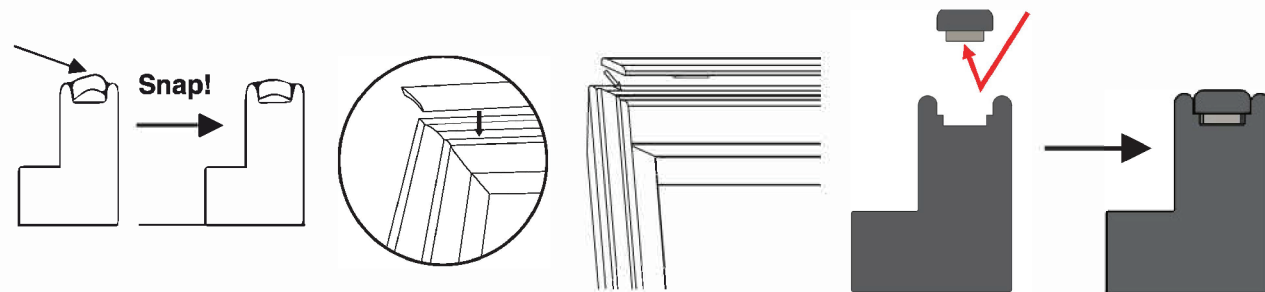

Maintain Your Shutter

Use a clean dry cloth, feather duster or vacuum with brush attachment to gently remove dust and debris. To ensure thorough cleaning, wipe the louvers in the open and closed positions.

Do not immerse the product in water and do not use harsh chemicals to clean. This may cause discoloration and the wood to warp. Ultrasonic cleaning is not recommended. For best results on Composite Shutters, use a cotton cloth dampened with water. Polyester cloths tend to create static, which can attract dust.

Adjust the Tension System

If over a period of time the louvers on your shutters should loosen or not function properly, a built-in tension system can be adjusted. Simply open the panels fully and find the tension adjuster screw hole on the side of each panel. Use a screwdriver to gently turn the screw on each side of the panel to your desired resistance level. Repeat process for other panel(s) if necessary.

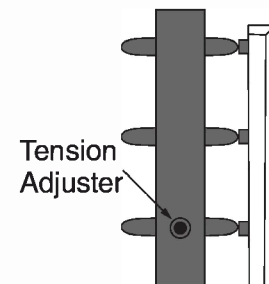

Lifetime Limited Warranty

All Acadia Living shutters have a lifetime limited warranty and will be free from defects in materials or workmanship for as long as the original retail purchaser owns the shutters, provided that such products were properly installed in residential dwelling; and such products were made or assembled exclusively from original materials and components. Any resale or other transfer of the product and/or materials voids this warranty.

For a complete copy of this warranty, please contact customer service by phone or email.

Customer Service

Phone: 855.667.6261

Email: Blinds.comSupport@NormanUSA.com

ACADIA

LIVING™

Shutter Installation Instructions Vintage L Frame Outside Mount 4 Sides

CONGRATULATIONS on purchasing the finest shutters in the market. You can take pride that your purchase will enhance the function and beauty of your home.

Installation Overview

- Getting Started
- Step 1: Assemble Frame
- Step 2: Level the Frame
- Step 3: Secure the Frame
- Step 4: Attach the Panels
- Step 5: Add the Finishing Touch



IMPORTANT: Do not mix panels or frames from other windows. Install one shutter at a time.

Tools needed for installing your shutter:

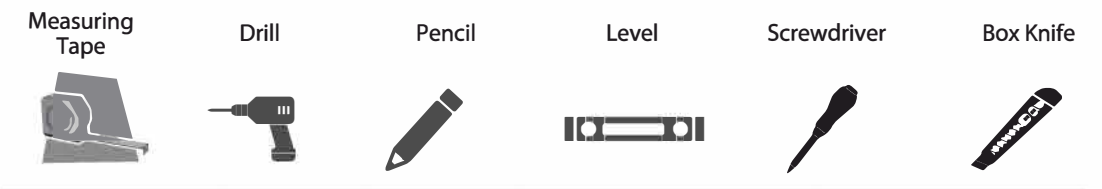

Getting Started

Remove the shutter from the package. Do not discard any of the packaging material until the shutter operates to your satisfaction. Check the diagram below to make sure you have the necessary parts.

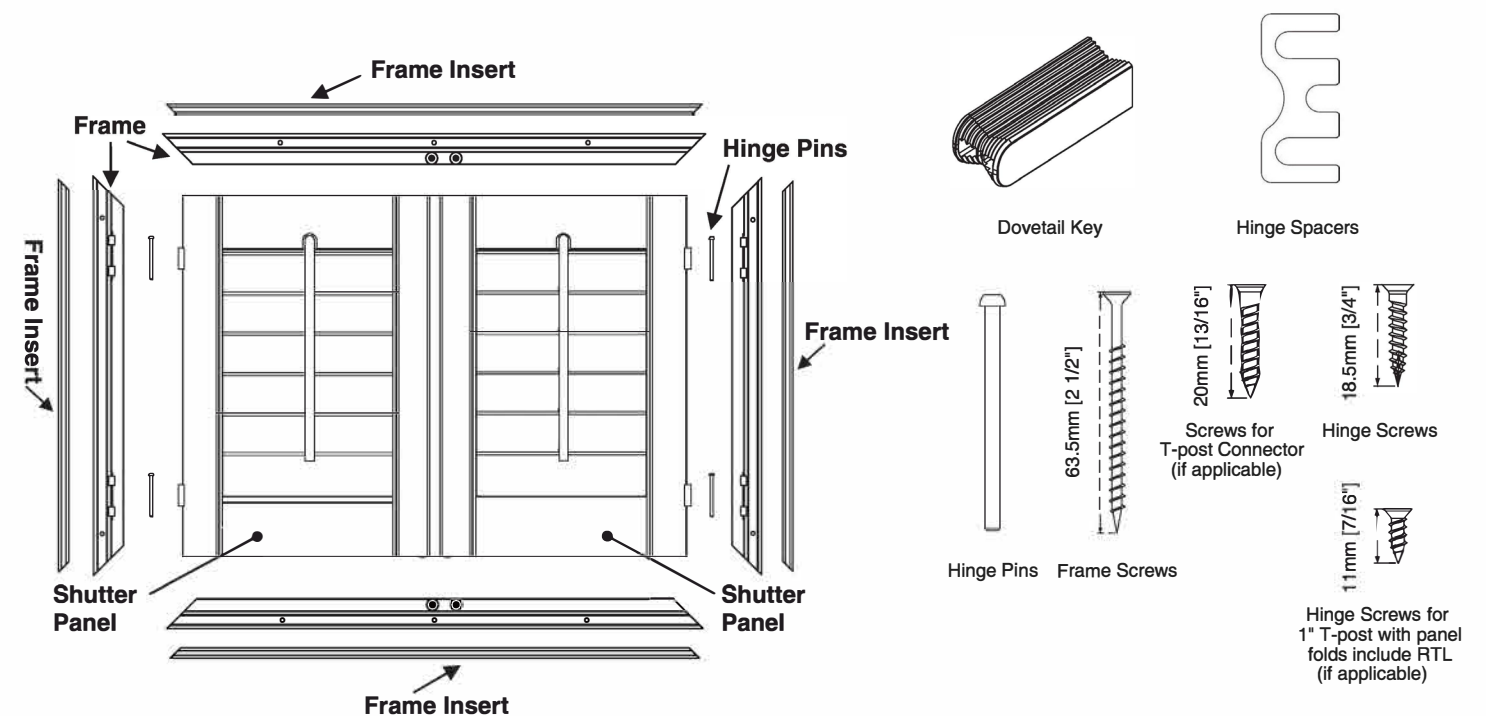

Step 1: Assemble the Frame

- Carefully remove panels and frames from the packaging. Do not mix panels or frames from other windows. Frame pieces are labeled: top, left, right, and bottom. To separate the frame inserts from the frames, gently lift the frame insert from one side of the frame. Then carefully slide the insert out of the frame.

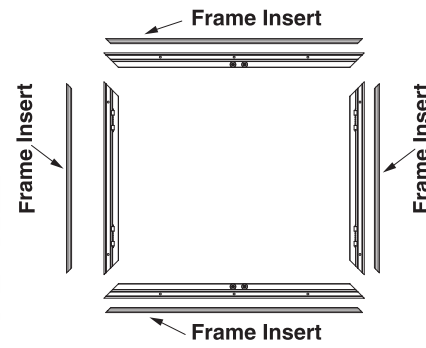

Scan the QR code to watch how to remove the frame inserts.

- Set all frames on a soft, level surface (moving blankets or some type of pad works best). Position each side of the frame and line up the Dovetail Key slot.

※ If not installing with T-POST, skip to #5.

- The top and bottom of the T-post are labeled. Locate and identify. Line up the pre-drilled holes with the top and bottom frame and secure with screws provided. Fasten the T-post with additional nails if necessary.

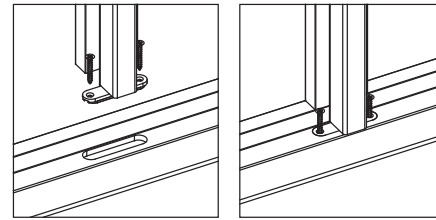

- ⚠ The T-post connector provides some wiggle room: make sure the T-post is at the center position at each end and secure with two screws. The T-post can also be adjusted when gaps between panels are not even.

- Insert the Dovetail Key into each slot at the back of the frame. Use a rubber mallet if necessary.

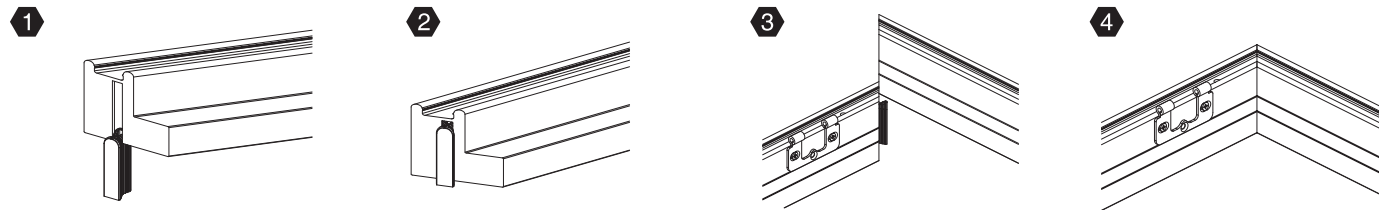

- ⚠ The Dovetail Key has a rounded side and a flat side. The rounded side should be inserted in slot first.

With the rounded side of the Dovetail Key facing up, push the top frame down onto the Dovetail Key.

Step 2: Level the Frame

Position the assembled frame evenly around the window opening against the window edges. Then secure one screw into the upper left frame ONLY. Once done, level the frame on the window.

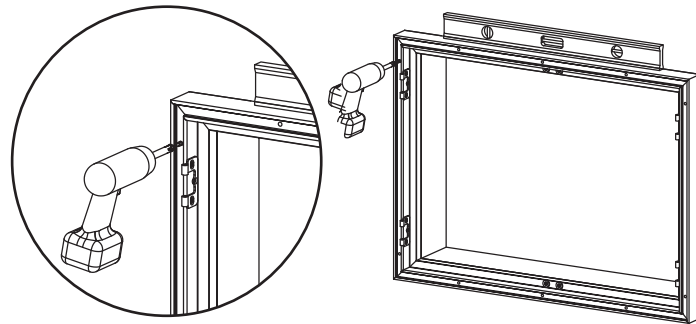

Step 3: Secure the Frame

To keep the frame level, tighten one screw into the upper right frame. The shutters will be fully secured in later steps.

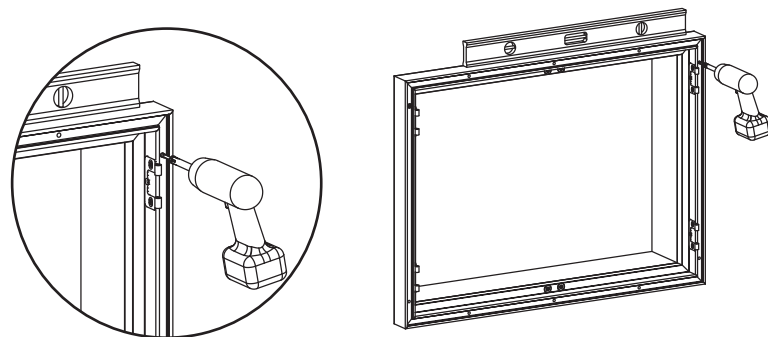

Step 4: Attach the Panels

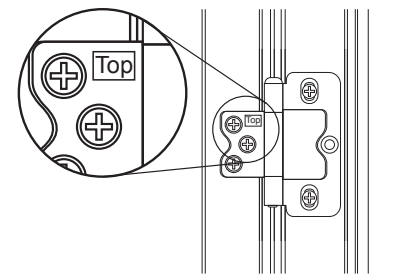

- ⚠ To ensure panels are installed correctly: Identify the top and bottom of the panel by locating the top label on the top hinge.

- Place the left shutter panel in the frame, align the hinges, and insert the hinge pin. Repeat for the right shutter panel.

If you have bi-fold panels, after attaching the far left and/or far right panels to the frame, you will need to join the hinges of the panels labeled P1 and P2 and insert hinge pins. Repeat for panels labeled P3 and P4 if you have these. Proper order of panels from left to right is P1, P2, P3, P4.

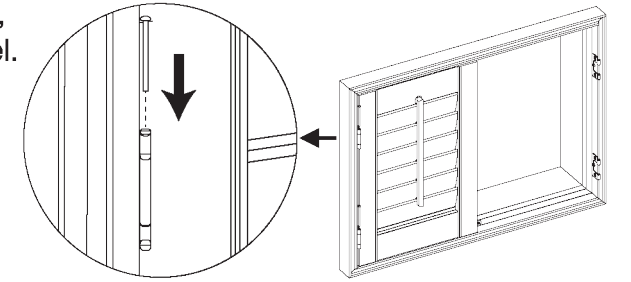

- If panel hinges are not aligned with frame hinges properly, then frame hinges can be adjusted.

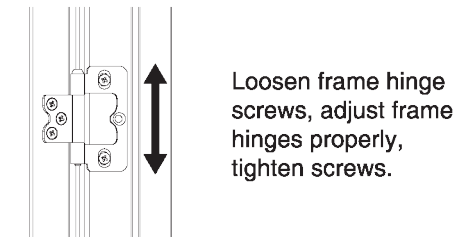

- Please check the gap between panel and frame at the top and bottom. The gap should be even; if not, then shift frame left to right until the gap is even.

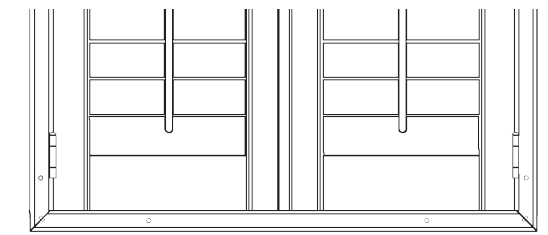

- Once even, secure a screw at the bottom of the left frame and right frame.

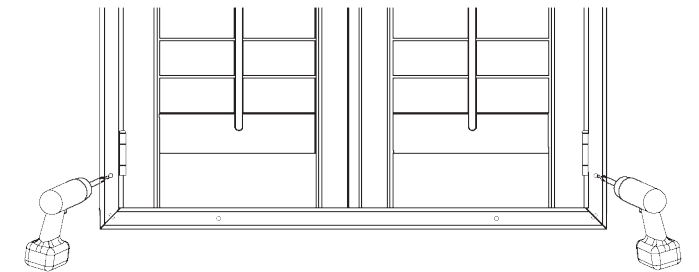

- Check gap between panels and adjust accordingly with hinge spacers provided if needed.

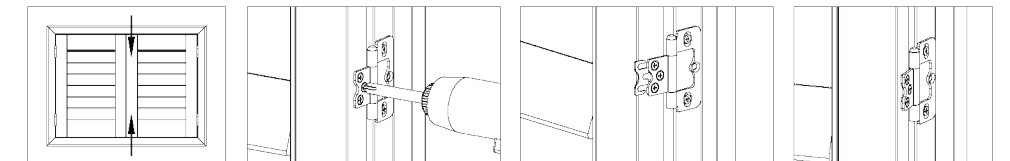

Loosen hinge screws on the panel Insert spacer behind hinge, tighten screws Spacer installed

- Open and close panels to make sure panels operate properly. Secure the frame with screws through the rest of the pre-drilled holes.

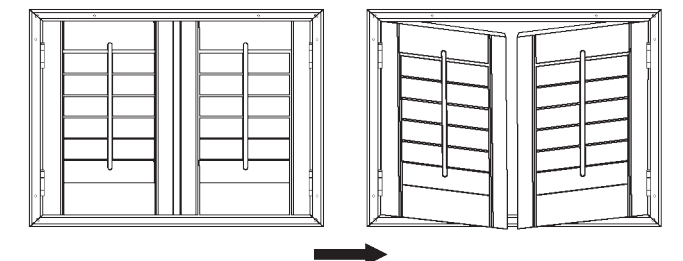

Step 3: Secure the Light Block

1. Open shutter panels and position the light block on the window sill. The front of the light block should be flush with the front of the left and right frames. Make sure magnets on panels will latch onto the magnet catches on the light block.
2. Once aligned properly, secure the light block with the light block screws provided through each pre-drilled hole.

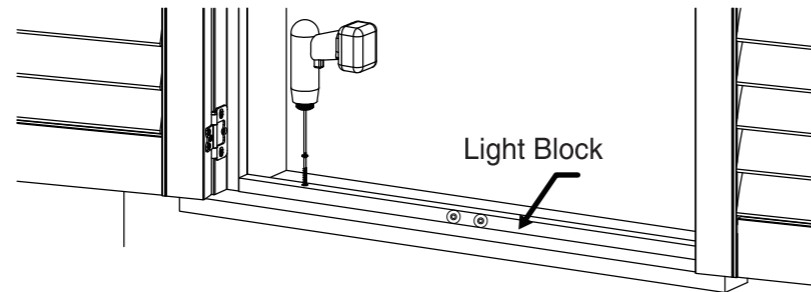

Step 4: Install the Plugs

Install the plugs into the frames' pre-drilled plug holes to complete the look of your shutters.

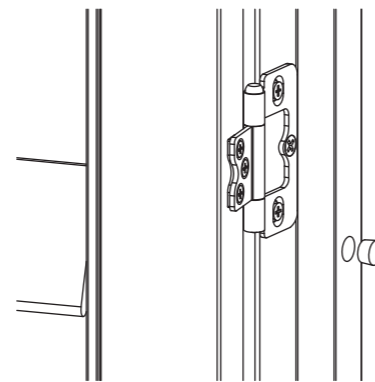

Maintain Your Shutters

Use a clean dry cloth, feather duster or vacuum with brush attachment to gently remove dust and debris. To ensure thorough cleaning, wipe the louvers in the open and closed positions. Do not immerse the product in water and do not use harsh chemicals to clean. This may cause discoloration and the wood to warp. Ultrasonic cleaning is not recommended. For best results on Composite Shutters, use a cotton cloth dampened with water. Polyester cloths tend to create static, which can attract dust.

Adjust the Tension System

If over a period of time the louvers on your shutters should loosen or not function properly, a built-in tension system can be adjusted. Simply open the panels fully and find the tension adjuster screw hole on the side of each panel. Use a screwdriver to gently turn the screw on each side of the panel to your desired resistance level. Repeat process for other panel(s) if necessary.

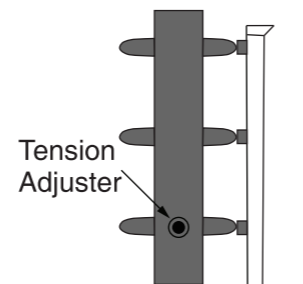

Lifetime Limited Warranty

All Acadia Living shutters have a lifetime limited warranty and will be free from defects in materials or workmanship for as long as the original retail purchaser owns the shutters, provided that such products were properly installed in residential dwelling; and such products were made or assembled exclusively from original materials and components. Any resale or other transfer of the product and/or materials voids this warranty.

For a complete copy of this warranty, please contact customer service by phone or email.

Customer Service

Phone: 855.667.6261
Email: Blinds.comSupport@NormanUSA.com

ACADIA

LIVING™

Shutter Installation Instructions Z Frame Inside Mount 2 Sides Cafe Shutters

CONGRATULATIONS on purchasing the finest shutters in the market. You can take pride that your purchase will enhance the function and beauty of your home.

INSTALLATION OVERVIEW

- Getting Started
- Step 1: Assemble Frame
- Step 2: Attach the Panels
- Step 3: Secure the Light Block
- Step 4: Install the Plugs



Installation Video

Scan the QR code with your smartphone to follow along with video instructions.



IMPORTANT: Do not mix panels or frames from other windows. Install one shutter at a time.

Tools needed for installing your shutter:



Getting Started

Remove the shutter from the package. Do not discard any of the packaging material until the shutter operates to your satisfaction. Check the diagram below to make sure you have the necessary parts.

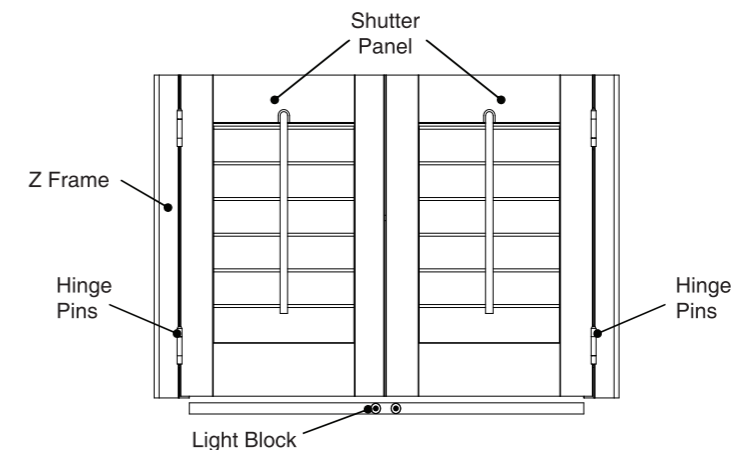

Z Frame Inside Mount 2 Sides Cafe Shutter

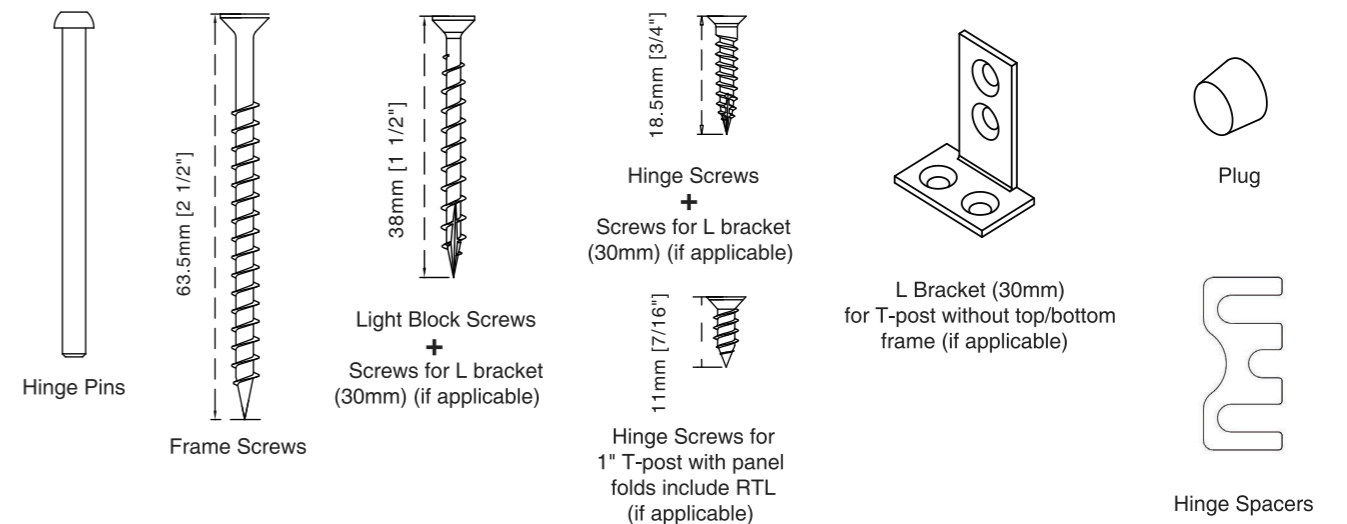

Step 1: Assemble Frame

1. Carefully remove panels and frames from the packaging.
Do not mix panels or frames from other windows.
Frame pieces are labeled (left and right).

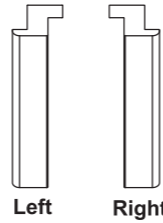

2. Place the frame side that has the pre-installed hinges into the correct side of the window opening.

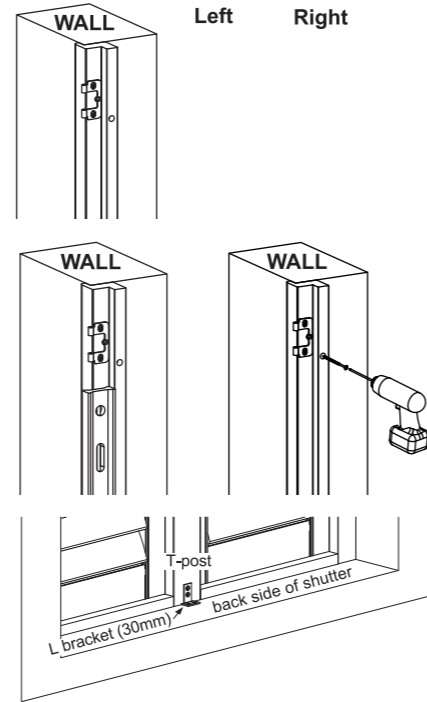

3. Using a level, ensure the frame is straight up and down.
Temporarily secure to the opening with a screw at the top and bottom of the frame. Use shims if necessary to keep frame straight up and down.

4. If installing with T-post, use L bracket (30mm) to secure the T-post. Fasten the T-post with additional nails if necessary.
If not installing with T-post, skip to the next step.

Step 2: Attach the Panels

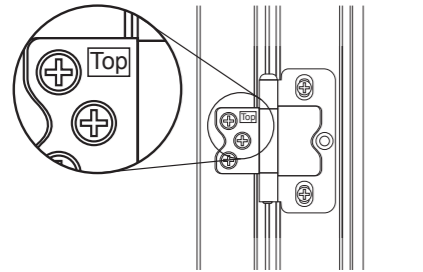

⚠ To ensure panels are installed correctly:
Identify the top and bottom of the panel by locating the top label on the top hinge.

Single panel or hinged on 1 side only

1. Insert the shutter panel into the frame hinges and secure the hinges with supplied hinge pins.

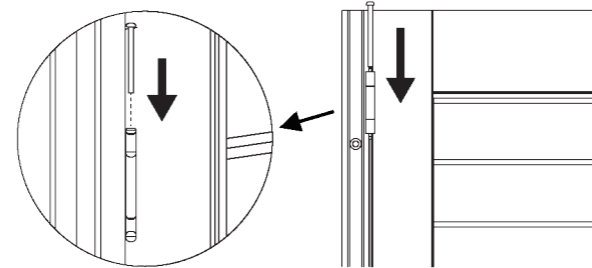

If you have bi-fold panels, start by securing this first panel to the frame. Then join the hinges of the panels labeled P1 and P2 and insert the hinge pins.

2. Operate the panel to ensure it opens and closes freely. The hinges may be adjusted up or down to increase or decrease bottom spacing.

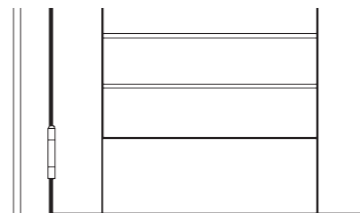

3. Make sure frame is straight up and down with the level and temporarily secure with screws for non-hinged frame.

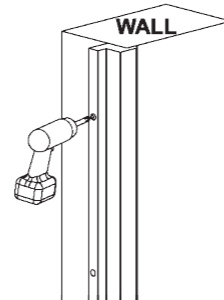

Version 37103-65200-A

4. Close panel against the non-hinged frame and check to see there is approximately 1/8" of space between the panel and frame. Adjust as necessary to achieve even spacing.

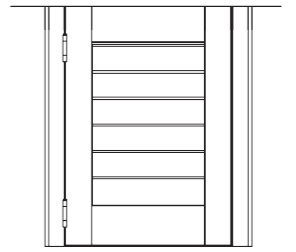

5. Secure both frames using shims if necessary to maintain spacing.
Open & close panel and make any final adjustments. Use provided hinge spacers to adjust spacing if necessary.
Once desired spacing has been achieved, secure frames with remaining screws.

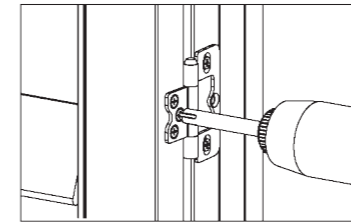

Loosen hinge screws on the panel

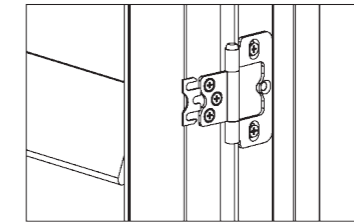

Insert spacer behind hinge, tighten screws

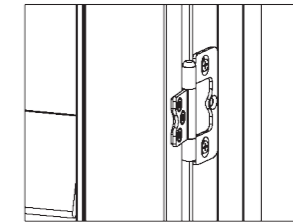

Spacer installed

6. Fasten the deadlock screw for all hinges.

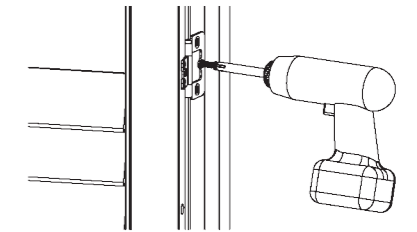

Multiple panels – hinged on both frames

1. Temporarily install both left and right frames using directions in Step 1, #3.

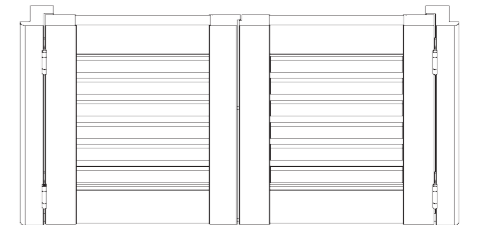

2. Insert panels into both the left and right frames and secure with hinge pins.

If you have bi-fold panels, after attaching the far left and/or far right panels to the frame, you will need to join the hinges of the panels labeled P1 and P2 and insert hinge pins. Repeat for panels labeled P3 and P4 if you have these. Proper order of panels from left to right is P1, P2, P3, P4.

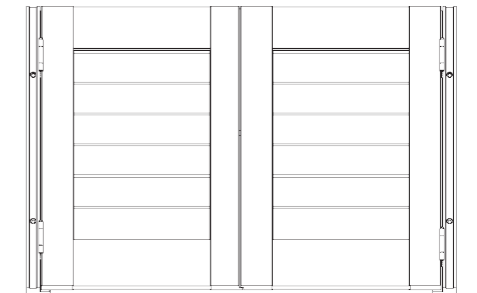

3. Close the left and right panel sections and check center spacing. Adjust frames using shims or hinge spacers to achieve even spacing where the center panels come together.

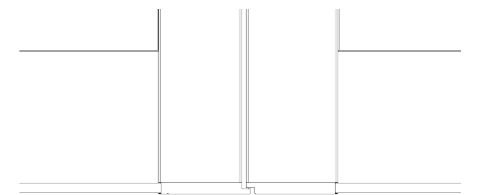

4. Once desired spacing has been achieved, secure frames with remaining screws.

5. Fasten the deadlock screw for all hinges.

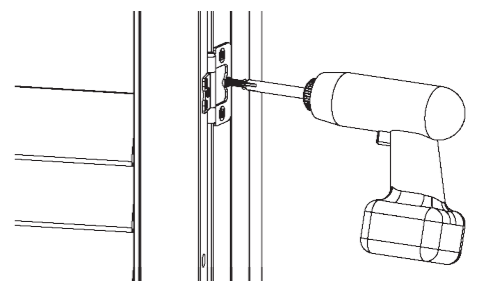

7. Fasten the deadlock screw for all hinges.

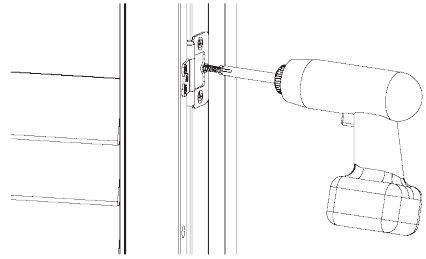

Step 5: Install the Plugs

Install the plugs into the frames' pre-drilled plug holes to complete the look of your shutters.

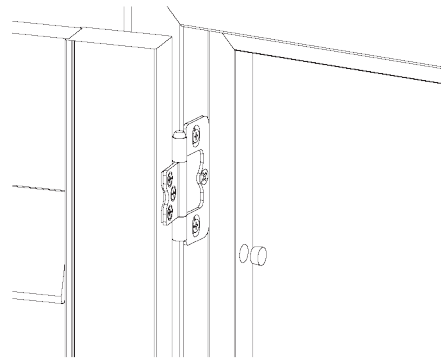

Maintain Your Shutter

Use a clean dry cloth, feather duster or vacuum with brush attachment to gently remove dust and debris. To ensure thorough cleaning, wipe the louvers in the open and closed positions. Do not immerse the product in water and do not use harsh chemicals to clean. This may cause discoloration and the wood to warp. Ultrasonic cleaning is not recommended. For best results on Composite Shutters, use a cotton cloth dampened with water. Polyester cloths tend to create static, which can attract dust.

Adjust the Tension System

If over a period of time the louvers on your shutters should loosen or not function properly, a built-in tension system can be adjusted. Simply open the panels fully and find the tension adjuster screw hole on the side of each panel. Use a screwdriver to gently turn the screw on each side of the panel to your desired resistance level. Repeat process for other panel(s) if necessary.

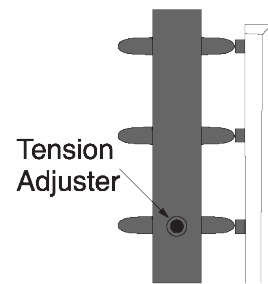

Lifetime Limited Warranty

All Acadia Living shutters have a lifetime limited warranty and will be free from defects in materials or workmanship for as long as the original retail purchaser owns the shutters, provided that such products were properly installed in residential dwelling; and such products were made or assembled exclusively from original materials and components. Any resale or other transfer of the product and/or materials voids this warranty.

For a complete copy of this warranty, please contact customer service by phone or email.

Customer Service

Phone: 855.667.6261

Email: Blinds.comSupport@NormanUSA.com

ACADIA

LIVING™

Shutter Installation Instructions Z Frame Inside Mount 4 Sides or 3 Sides with Bottom Sill Plate

CONGRATULATIONS on purchasing the finest shutters in the market. You can take pride that your purchase will enhance the function and beauty of your home.

Installation Overview

- Getting Started
- Step 1: Assemble Frame
- Step 2: Level the Frame
- Step 3: Secure the Frame
- Step 4: Attach the Panels
- Step 5: Install the Plugs



IMPORTANT: Do not mix panels or frames from other windows. Install one shutter at a time.

Tools needed for installing your shutter:



Getting Started

Remove the shutter from the package. Do not discard any of the packaging material until the shutter operates to your satisfaction. Check the diagram below to make sure you have the necessary parts.

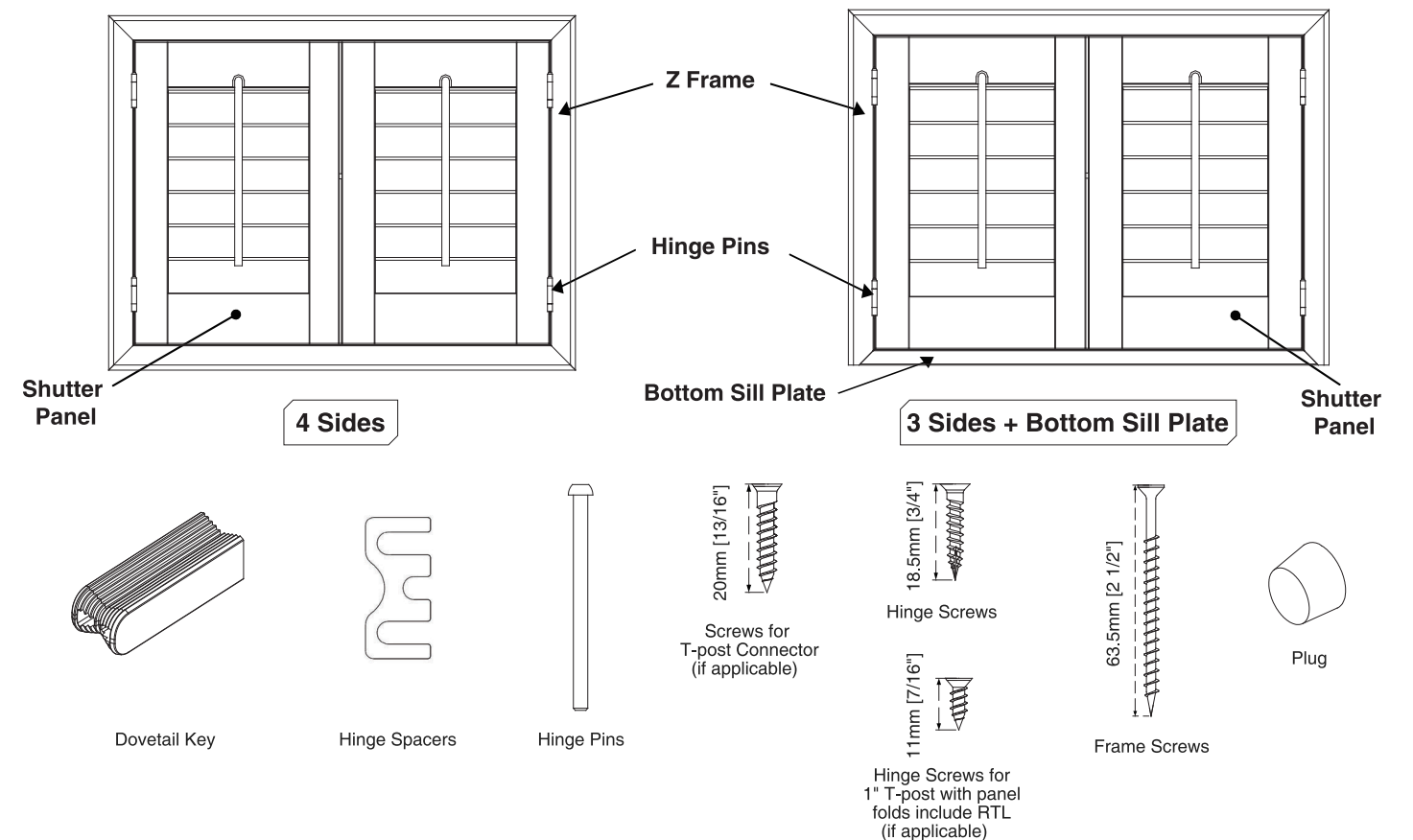

Step 1: Assemble the Frame

- Carefully remove panels and frames from the packaging. All frame parts are labeled (top, bottom, left, and right).

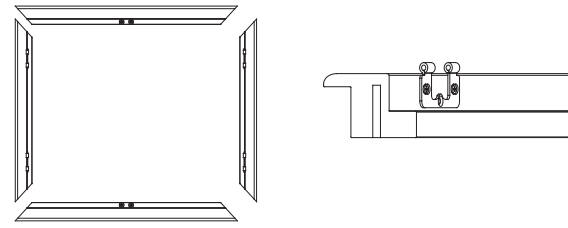

- Set all frames on a soft, level surface (moving blankets or some type of pad works best). Position each side of the frame and line up the Dovetail Key slot.

※ If not installing with T-POST, skip to #4.

- The top and bottom of the T-post are labeled. Locate and identify. Line up the pre-drilled holes with the top and bottom frame and secure with screws provided. Fasten the T-post with additional nails if necessary.

⚠ The T-post connector provides some wiggle room: make sure the T-post is at the center position at each end and secure with two screws. The T-post can also be adjusted when gaps between panels are not even.

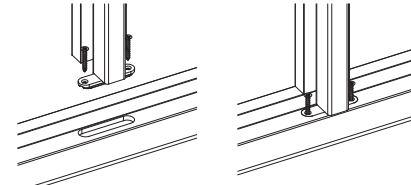

- Insert the Dovetail Key into each slot at the back of the frame. Use a rubber mallet if necessary.

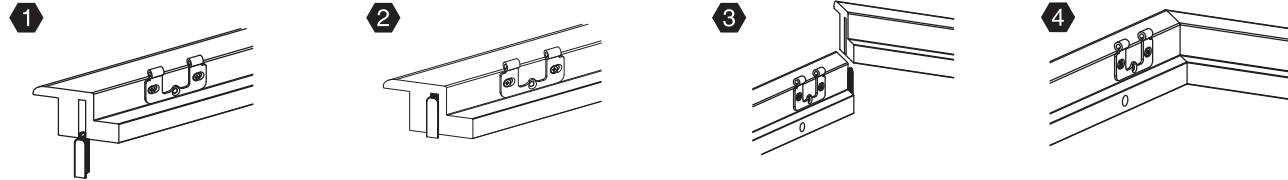

⚠ The Dovetail Key has a rounded side and a flat side. The rounded side should be inserted in slot first.

With the rounded side of the Dovetail Key facing up, push the top frame down onto the Dovetail Key.

- The frames are pre-drilled in the top left and right frame, bottom left and right frame, and/or in the middle of each frame. Double check that all the holes are pre-drilled before placing the frame on the window.

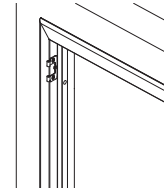

Step 2: Level the Frame

Position the assembled frame evenly along the window opening against the window. Then secure one screw into the upper left frame ONLY. Once done, level the frame on the window.

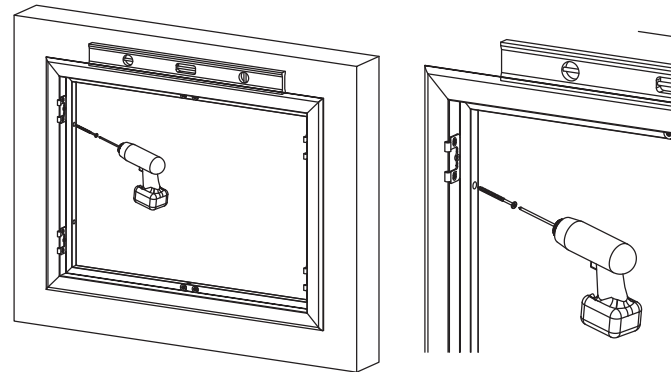

Step 3: Secure the Frame

To keep the frame level, tighten one screw into the upper right frame. The shutters will be fully secured in later steps.

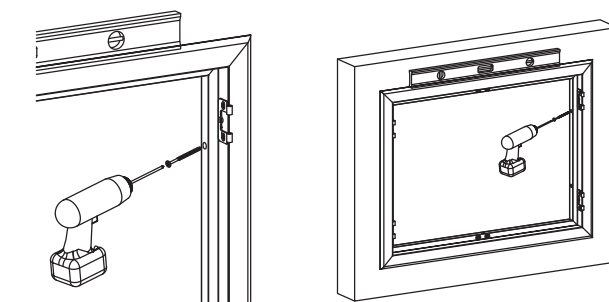

Only secure one screw into the top right frame

Step 4: Attach the Panels

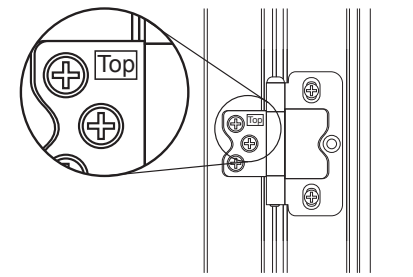

⚠ To ensure panels are installed correctly: Identify the top and bottom of the panel by locating the top label on the top hinge.

- Place the left shutter panel in the frame, align the hinges, and insert the hinge pin. Repeat for the right shutter panel.

If you have bi-fold panels, after attaching the far left and/or far right panels to the frame, you will need to join the hinges of the panels labeled P1 and P2 and insert hinge pins. Repeat for panels labeled P3 and P4 if you have these. Proper order of panels from left to right is P1, P2, P3, P4.

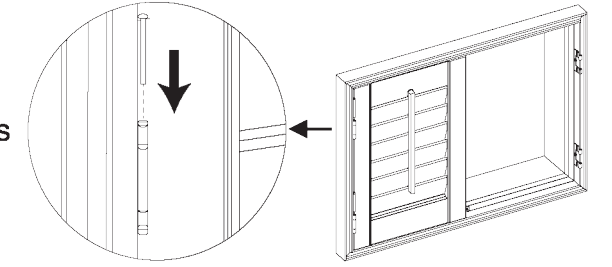

- If panel hinges are not aligned with frame hinges properly, then frame hinges can be adjusted.

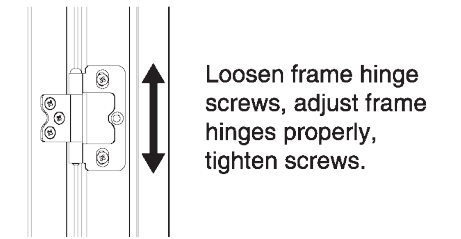

Loosen frame hinge screws, adjust frame hinges properly, tighten screws.

- Please check the gap between panel and frame at the top and bottom. The gap should be even; if not, then shift frame left to right until the gap is even.

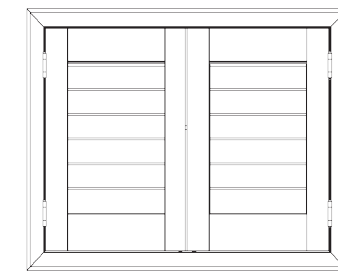

- Once even, secure a screw at the bottom of the left frame and right frame.

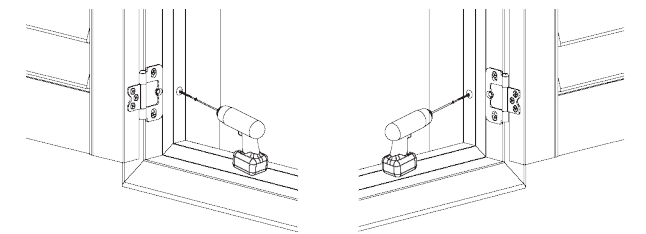

- Check gap between panels and adjust accordingly with hinge spacers provided if needed.

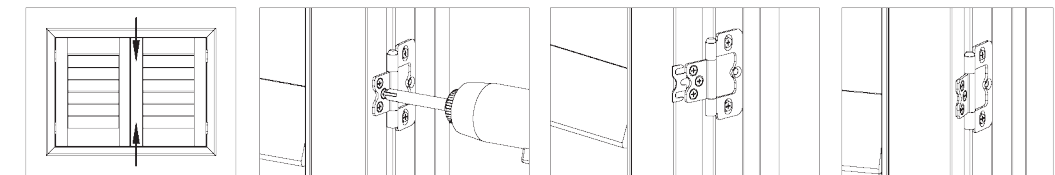

Loosen hinge screws on the panel

Insert spacer behind hinge, tighten screws

Spacer installed

- Open and close panels to make sure panels operate properly. Secure the frame with screws through the rest of the pre-drilled holes.

