

Custom Cordless Roman Shade

owner's handbook



WARNING

Cords and bead chains can loop around a child's neck and strangle.

- Always keep cords and bead chains out of children's reach.
- Move furniture away from cords and bead chains. Children can climb furniture to get to cords.
- Do not tie cords together. Make sure cords do not twist together and create a loop.

IMPORTANT INFORMATION ABOUT YOUR ROMAN SHADE

This product is designed to make your shade safer for children and pets. However, this shade is substantially different than the traditional shades that you might be accustomed to.

This shade has a double cording system on the back of the shade to help minimize the possibility of a child or pet becoming entangled in the cords.

See the operating instructions toward the back of this handbook for additional information about the function of your shade.

INSTALLATION INSTRUCTIONS

Step 1. Check Package Contents

Missing part? Call 1-800-264-1190

Mounting hardware kit includes the following:

Part	Quantity
Mounting Bracket	2 (for shades 24" to 36" wide)
	3 (for shades 36 $\frac{1}{8}$ " to 54" wide)
	4 (for shades 54 $\frac{1}{8}$ " to 84" wide)
1 $\frac{1}{8}$ " Screws	2 per bracket
Control Handle (attaches to bottom rail)	2

Note: one extra screw of each noted size is included for convenience

Step 2. Tools Required

Screwdriver, tape measure, pencil, drill, step ladder.

Note: use #6 plastic anchors for dry wall or plaster mounting (not included)

Drill Bits: for screws, use a 3/32" drill bit - for wall anchors, use 1/4" drill bit.

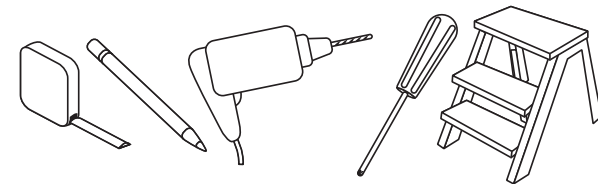

Step 3. Attach Pleat Stiffeners

If the Pleat Stiffeners are not pre-attached, snap them onto the bottom hem as illustrated, by pressing down firmly on each end of each stiffener. Do not press down in the center of the stiffener as it can break. The bottom pleat must have rigidity in order for the shade to function properly.

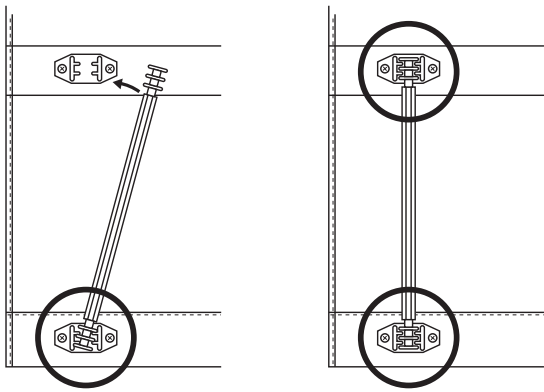

Step 4. Bracket Location and Installation

Your shade may be installed either inside the window frame or outside the window frame.

A mounting bracket should be positioned about 1" to 6" from each end of the head rail. For wider shades that require 3 or more brackets, these should be spaced evenly between the two outermost brackets. Always position the brackets such that there is no interference with the cords and mechanisms inside the head rail. The procedure outlined below will assure proper bracket placement.

Note that the shape of head rails and mounting brackets varies by style of shade.

For style 'A' [see illustration]: To attach the brackets the locking arm should be facing out. Then position the bracket so that it engages the inner front and outer back of the head rail, and then push the locking arm inward to lock it in place.

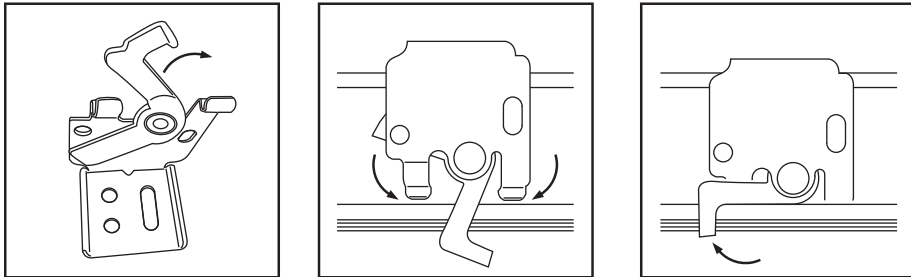

For style 'B' [see illustration below]: Lift the Head Rail into position such that the front edge of the bracket is under the inner front edge of the head rail, and then push the head rail upward until the flexible tab at the bottom of each bracket snaps onto the back of the head rail. Check carefully to assure that each bracket is properly secured.

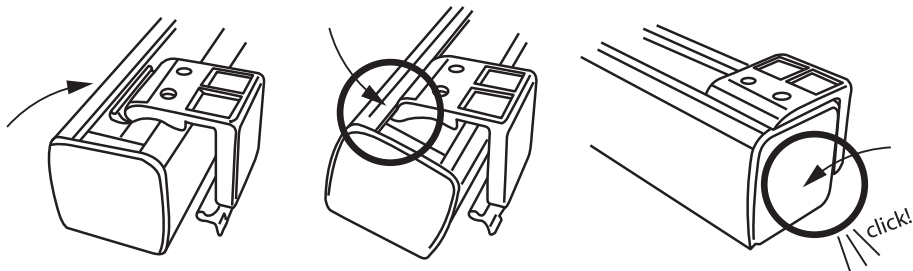

For Outside Mounting:

Attach the brackets to the head rail as described above. Hold the shade level at the

LIMITED LIFETIME WARRANTY

The enclosed product is warranted to the original residential retail purchaser as long as the product remains in the original window

Covered:

Lifetime: Entire product against manufacturing defects (i.e. a flaw in the product design, materials, or workmanship that causes the product to no longer function).

3 Years: Cords, including internal cords such as those found in cordless blinds or shades.

5 Years: All fabric

Not Covered:

Normal Wear and Tear

Any product that fails due to:

- abuse
- exposure to salt air

- improper installation
- accident
- extraordinary use
- improper operation
- alterations
- improper cleaning
- misapplication
- damage from pests/insects/pets
- improper handling
- misuse

Costs associated with:

- product removal
- transportation to and from the retailer
- brand label removal
- product re-measure
- incidental or consequential damages
- product reinstallation
- shipping

In the event there are multiple blinds/shades in the same room, only the defective blind/shade will be replaced.

To Report Shipping Damage: If damage occurred during shipping, call place of purchase and report within 7 calendar days or else you may be denied credit for your damaged product.

To Obtain Service: If you suspect this product has a manufacturing defect in materials or workmanship: 1. Locate the sales receipt 2. Call place of purchase. Any unauthorized returns will not be accepted.

Warranty Remedy: THIS SHALL BE YOUR SOLE REMEDY UNDER THIS LIMITED WARRANTY.

If this product is found to have a manufacturing defect in materials or workmanship, we will (at our discretion) do one of the following:

- repair the product
- replace the product
- refund the cost of the product

Colors vary from lot to lot and may not exactly match sample swatch or previous purchases.

Discontinued items or color selections will be replaced with the closest equivalent current product.

YOUR RIGHTS UNDER STATE LAW:

This lifetime limited warranty gives you specific legal rights, and you may have other rights, which vary from state to state. Some states do not allow limitations on how long a warranty lasts, so the above limitations may not apply to you. No agent, representative, dealer, or unauthorized employee has the authority to increase or alter the obligation of this warranty. This lifetime limited warranty supersedes any previous versions.

For all questions, please call (800) 264-1190
Hours of operation are 8:00am to 5:00pm CST

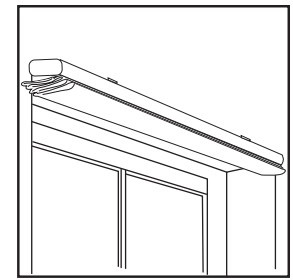
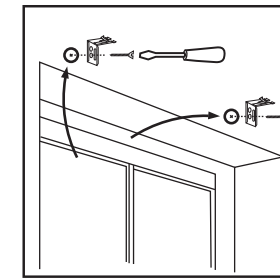
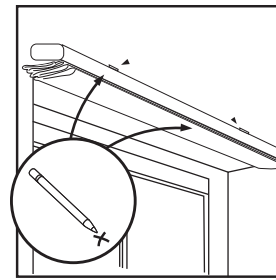

height desired and center it over the window opening. Mark the exact location of each bracket with a pencil.

Remove the brackets from the head rail and position the top of each bracket at the marked location and screw each bracket into the wall or window molding using the 1/8" screws, pre-drill the screw holes using a 5/64" drill bit.

For Inside Mounting:

Clip the brackets onto the head rail as described above. Hold the shade in place and make a pencil mark at the rear of each bracket where it contacts the inside of the window frame.

Remove the brackets from the head rail and align them with the marks. Attach each bracket using the 1/8" screws, pre-drill the screw holes using a 5/64" drill bit.

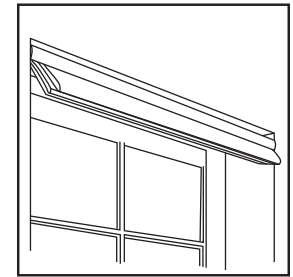
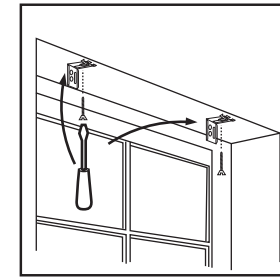
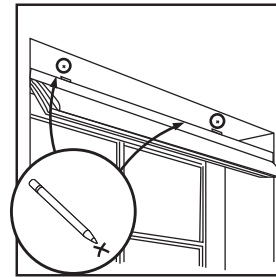

Step 5. Securing the Head Rail

Place the head rail on the brackets as described in Step 4 above, and lock in place. Check carefully to assure that each bracket is properly secured.

Step 6. Attach Handle / How to Operate

Attach the handles to the bottom of the shade as illustrated.

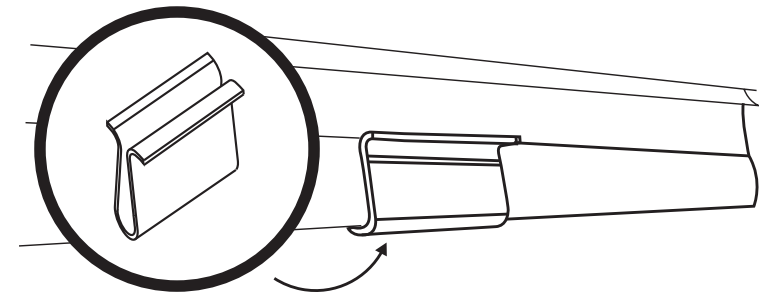

Positioning: Divide the width of the shade by 4, and place a handle that distance from each end of the shade. The handles are designed to minimize contact with the shade fabric.

Lowering the Shade: Grip the handles and slowly pull straight down.

IMPORTANT

Always keep the bottom rail level (i.e. parallel to the top of the shade) when lifting and lowering the shade. If the shade becomes uneven, slowly pull it all the way down and then lift to the desired position. If necessary, reach behind the shade and manually pull the cording slowly out of the head rail until the bottom of the shade is level.

Raising the Shade: SLOW is the functional word in achieving proper operation of your cordless shade. To lift the shade, place your hands on the handles with palms facing up. Pull the bottom pleat very slightly away from the window and then push upward slowly. The pleats should fold like an accordion. If the bottom pleat is pushed straight up, it will tend to go behind and overlap the other pleats which prevents the shade from operating properly. If the bottom pleat is pulled too far it likewise will not function properly. See the video for a demonstration of the recommended lifting technique.

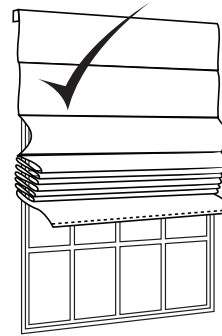
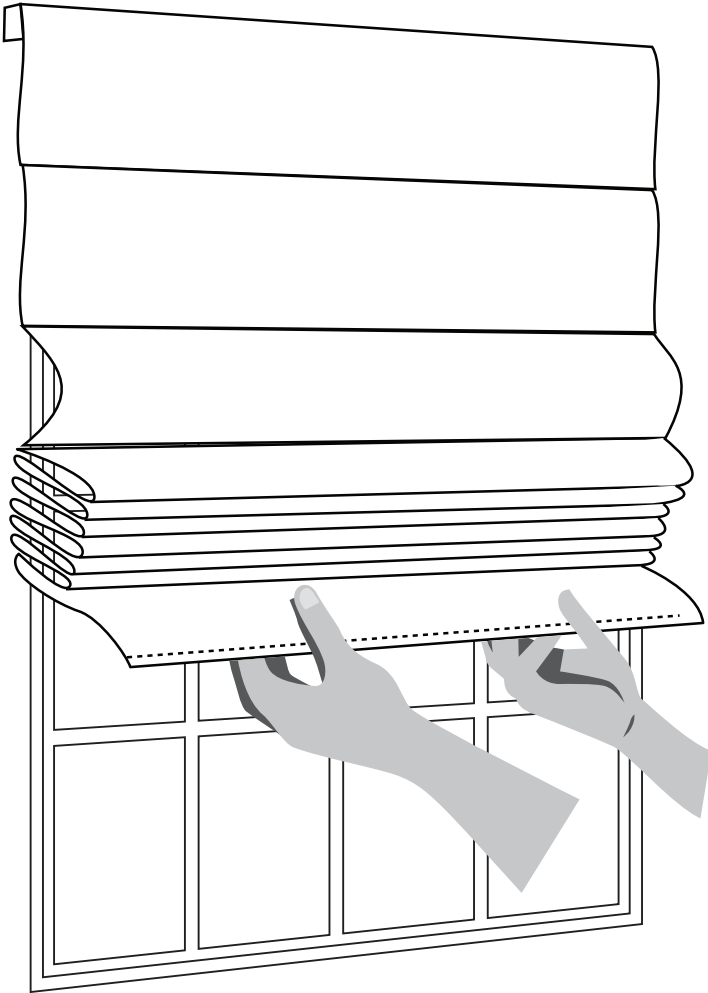

Correct(!) – pleats are folding neatly

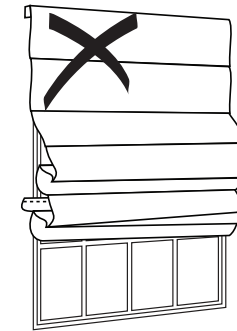

Do not let the bottom pleat go behind and overlap the other pleats as the shade will not operate properly

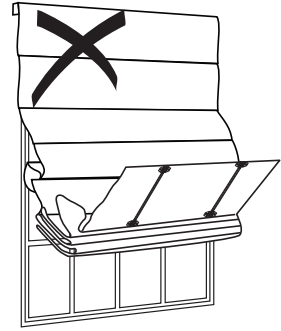

Do not pull the bottom pleat out too far or the shade will not function properly

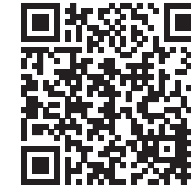

Use your phone camera to scan code for instructional video or visit:
https://www.youtube.com/watch?v=h_N4AeJ-v1E&feature=youtu.be

Cleaning your Shades

To clean the shade fabric, use a feather duster or vacuum lightly using the soft brush attachment.

For 100% Polyester, Cotton/Poly blends and 100% Cotton or 100% Linen fabrics you may: Spot clean with warm soapy water using mild detergent and a clean sponge. Air dry, and then steam or iron.

Ironing

100% Polyester: If necessary, steam polyester or gently iron on a low heat setting to remove stubborn wrinkles. 100% Polyester fabrics release wrinkles easily. Steam or iron on the Polyester /

Synthetic Fabrics setting (Low), but be aware that Polyester will melt if the iron is too hot.

Cotton/Poly blends: If necessary, gently iron on a Blended Fabric (Medium) setting to remove stubborn wrinkles.

100% Cotton and 100% Linen: If necessary, gently iron on a Cotton (High) setting to remove stubborn wrinkles.

Replacement Parts

In the event that replacement parts are ever needed, you may call: 1-800-264-1190

Please be sure to provide the following information, if possible:

- The complete model or catalog number of your product
- A description of the product
- A description of the part needed

4. Costs associated with:

- Product removal • Transportation to and from the retailer • Brand label removal • Product re-measure
- Product reinstallation • Shipping
- Incidental or consequential damages

In the event there are multiple blinds/shades in the same room, only the defective blind/shade will be replaced

To Report Shipping Damage:

If damage occurred during shipping, call the place of purchase and report within 7 calendar days, or you may be denied credit for your damaged product.

To Obtain Service:

If you suspect this product has a manufacturing defect in materials or workmanship:

- Locate the sales receipt
- Call place of purchase

Any unauthorized returns will not be accepted.

Warranty Remedy:

This shall be your sole remedy under this limited warranty.

If this product is found to have a manufacturing defect in materials or workmanship, we

will, at our discretion, do one of the following:

- Repair the product
- Replace the product
- Refund the cost of the product

Colors may vary from lot to lot and may not exactly match sample swatches or previous purchases.

Discontinued items or color selections will be replaced with the closest equivalent current product.

Your rights under state law: This lifetime limited warranty gives you specific legal rights, and you may have other rights which vary from state to state. Some states do not allow limitations on how long a warranty lasts, so the above limitations may not apply to you. No agent, representative, dealer or unauthorized employee has the authority to increase or alter the obligation of this warranty. This lifetime limited warranty supersedes any previous versions.

For all questions,
please call (800) 264-1190

Hours of operation are
8:00am to 5:00pm CST

Custom Roman Shade with Cord Control

Mounting hardware kit includes the following:

Part	Quantity
Mounting Brackets	2 (shades up to 36" wide)
	3 (shades 36" to 48" wide)
	4 (shades 48" to 96" wide)
	5 (shades 96" to 120" wide)
1-1/4" Screws	2 (shades up to 36" wide)
	3 (shades 36" to 48" wide)
	4 (shades 48" to 96" wide)
	5 (shades 96" to 120" wide)
3/4" Screws for Outside Mount	2 (shades up to 36" wide)
	3 (shades 36" to 48" wide)
	4 (shades 48" to 96" wide)
	5 (shades 96" to 120" wide)
Screws for Tension Device	2 (1 1/4") Phillips head 1 (1/2") Phillips head per bracket for Inside Mount

Wallboard or Plaster: use anchors specifically designed for hollow walls (not included).

Concrete, Stone, Brick: use a masonry drill bit and anchors or screws specifically designed for masonry (not included).

Tools Required:

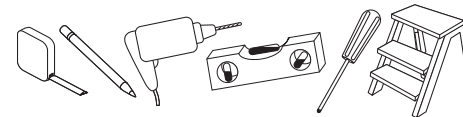

Pencil, tape measure, level, screw driver, step stool, drill, utility knife.

Installation:

For Outside Mounting

One bracket should be positioned about 2" to 6" from each end of the head rail. For wider shades that require 3 or more brackets, these should be spaced evenly between the two outermost brackets. Hold the shade in place and mark the desired bracket locations with a pencil.

The brackets must be level – use a Spirit Level if necessary to assure proper alignment.

Attach the brackets to the wall or window frame first. Pre-drill the mounting holes using a 5/64" drill bit, and then screw the brackets in place.

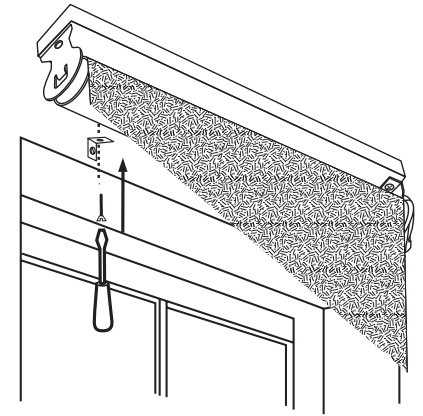

Place the head rail against the brackets as illustrated – center the shade over the window opening – then mark the location of each mounting hole on the head rail. Pierce the fabric at the hole locations using the tip of a screw, then pre-drill the mounting holes using a 5/64" drill bit. Attach the shade to the brackets using the 3/4" screws provided.

For Inside Mounting:

Mounting holes are pre-drilled in the Head Rail. Screw the 1-1/4" screws into the head rail until the tips of the screws extend very slightly beyond the top of the head rail. Align the front of the shade with

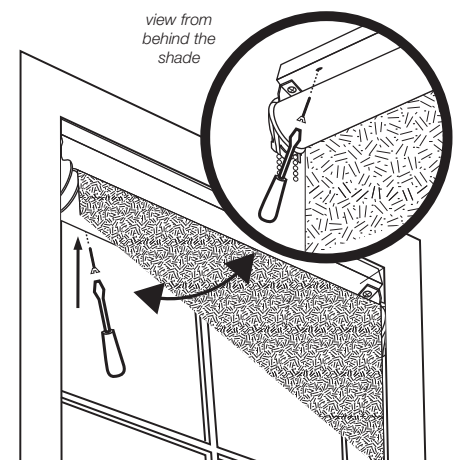

the front edge of the window opening (or position as desired), making sure that the shade is centered in the window opening – then push up on the screws so that the screw heads leave tiny impressions in the top of the window frame. Now, use the impressions as a guide and pre-drill the mounting holes using a 5/64” drill bit – then screw the shade in place.

Attach the Chain Tension Device

The Tension Device must be attached per these instructions in order for your shade to function properly.

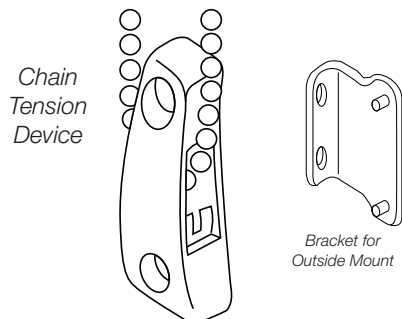

While holding the tension device in one hand, pull the plunger away from the bead chain with the other hand. Lift the bead chain out of the bead locking groove and slide the tension device to the bottom of the chain loop.

Remove the twist-tie from the Cord Control Mechanism.

Pull the tension device down until the bead chain is fully tensioned (plunger will be at the top) and then move the tension device up approximately 1/8”.

Mark the screw locations on the wall with a pencil.

Inside Mount: If mounting into wood, pre-drill screw holes and then install the tension device using the 1/4” Phillips head screws provided.

If not securing into wood, use appropriate anchors for the substrate and follow anchor manufacturer’s instructions.

Outside Mount: Align the mounting bracket screw holes with the pencil marks.

If mounting into wood, predrill screw holes and then install the mounting bracket using

the 1/4” Phillips head screws provided.

If not securing into wood, use appropriate anchors for the substrate and follow manufacturer’s instructions.

Press the tension device onto the mounting bracket posts. Carefully install the ” Phillips head screws provided, through the tension device into the mounting bracket using a Phillips head screwdriver.

DO NOT OVER-TIGHTEN!

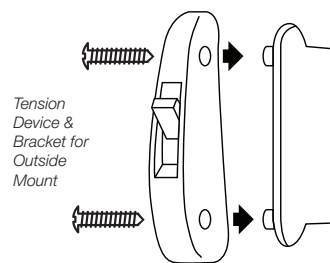

How to Operate Cord Control Shades

Pulling gently on the cord in one direction raises the shade; pulling it in the other direction lowers it.

General Cleaning Guidance:

- Dry Cleaning is the best method to clean soiled soft window treatments.
- However, on 100% Polyester, Cotton/ Poly blends and 100% Cotton or 100% Linen you may: Spot clean with warm soapy water using mild detergent and a clean sponge. Air-dry and then steam or iron.

WARNING

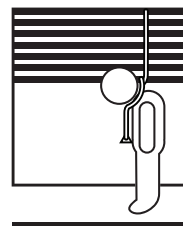

Window Blind Cord Can STRANGLE Your Child

- Children can climb furniture to reach cords.
- Move crib and furniture away.
- Keep all cords out of children’s reach.
- Attach tension device to wall or floor.
- Fasteners provided with tension device may not be appropriate for all amounting surfaces.
- Use appropriate anchors for the mounting surface conditions.

LIMITED LIFETIME WARRANTY

The enclosed product is warranted to the original residential retail purchaser as long as the product remains in the original window.

Covered

Lifetime: Entire product against manufacturing defects (i.e. a flaw in the product design, materials, or workmanship that causes the product to no longer function).

3 Years: Cords, including internal cords such as those found in cordless blinds or shades.

5 Years: All fabric

Not Covered

1. Normal wear and Tear
2. Any product that fails due to:
 - Abuse • Alterations • Exposure to salt air • Improper cleaning
 - Improper installation • Misapplication • Accident
 - Damage from pests/insects/pets • Extraordinary use
 - Improper handling • Improper operation • Misuse
3. Natural Wood Products that have:
 - Loss of color intensity • Variations in color, grain or texture
 - Warping of wood slats in high humidity areas