

## Metal Blinds with Hidden Brackets

Thank you for making Levolor a part of your home. You have chosen the finest metal blinds available, backed by the world renowned Levolor name. Learn more about Levolor and discover a resource of information, ideas, and support at [www.levolor.com](http://www.levolor.com).

**Read all  
installation instructions  
before installing.**

### **DANGER** STRANGULATION HAZARD

- Keep cords out of the reach of children.
- Move cribs and furniture away from cords.
- Remove objects below windows.
- Loops will appear when the shade is in the raised position.
- Do not tie cords together.
- Install a cord tensioner or cord cleat.



#### EMERGENCY FIRST AID FOR STRANGULATION

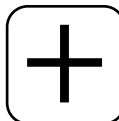

- Remove cord from child's neck
- Call 911 or Emergency Center
- Clear throat
- Check breathing and heartbeat
- Begin CPR

#### Contacting Us

To contact Levolor customer service regarding any questions or concerns you may have about your new blinds you may reach us at:

**1-800-LEVOLOR (9:00 am – 6:00 pm EST)**

[www.levolor.com](http://www.levolor.com)

#### Additional Parts and Services

- **Purchasing extra or replacement parts**  
Should the need arise, you may have your Levolor blinds repaired or restrung through our repair center. Please contact Levolor customer service through [www.levolor.com](http://www.levolor.com) for a return authorization number.

#### Operating your blinds

Your blinds are designed for many years of trouble-free operation. Following these instructions will help you get the most from your investment.

**IMPORTANT: The slats must be in the open position before raising or lowering the blinds.**

##### Adjusting slat tilt:

Rotate the tilt wand clockwise or counterclockwise to open or close the slats. **Do not force or pull down on the tilt wand!**

##### Raising or lowering the blinds:

###### Corded models:

Pull the cord gently toward the center of the window; then pull to raise or release to lower the blinds. If your blinds have hold-down brackets, make sure that the bottom rail is unhooked from the hold-down brackets before attempting to raise the blinds.

**Do not force the cord; if the blinds do not raise or lower, check for objects preventing proper operation.**

###### Cordless models:

**To lower your blinds**, place hand on bottom rail near the center or on the handle (on some models) and pull down. Release and blinds will stay in place.

**To raise your blinds**, place hand on bottom rail near the center or on the handle (on some models) and push up until desired location is reached. Release and blinds will stay in place.

#### Care and cleaning

To keep your blinds looking their best, wipe them periodically with a soft dust cloth or dusting mitt, or vacuum them using a round brush attachment.

##### Tips:

- Blinds can be cleaned in place or taken down for cleaning.
- By tilting the slats down to the almost closed position, you can clean most of the top surface of each slat. Tilting the slats up allows you to clean the bottom surface of each slat.

##### For hard-to-remove dust and dirt:

In a very dusty environment, you may need to clean your blinds using a sponge or dampened soft cloth.

- Place a towel on the floor or windowsill to catch any water that drips from the blinds.
- Use warm water and a mild nonabrasive detergent. Never use hot water, solvents, or harsh or abrasive cleansers to clean the blinds.
- Rinse the blinds with clean water to prevent water spots.

**NOTE:** The warranty for your blinds does not cover damage or discoloration caused by improper cleaning.

#### Before you begin your installation:

##### Read all installation instructions before you begin!

- Make sure that you have all tools and hardware needed for installation.
- Check the installation surface (wall, ceiling, or window frame) to ensure that you have suitable fasteners and tools for the material.
- Double check the headrail for proper width. If you are installing several sets of blinds, be sure to match them with the appropriate window.
- Check the parts list to confirm that you have the correct number and types of brackets.

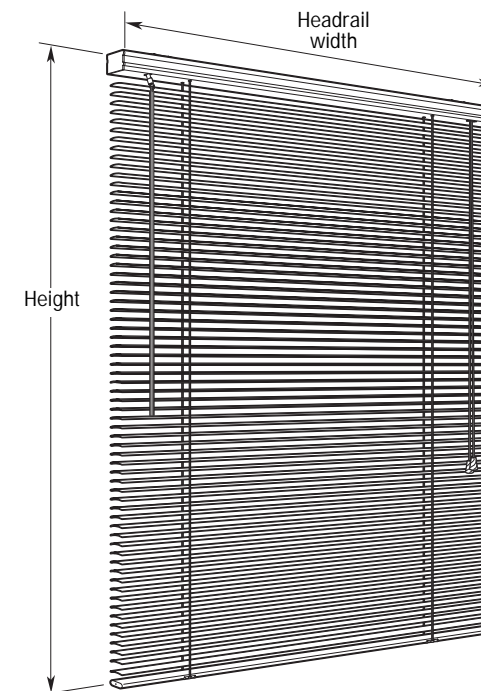

#### Key Parts

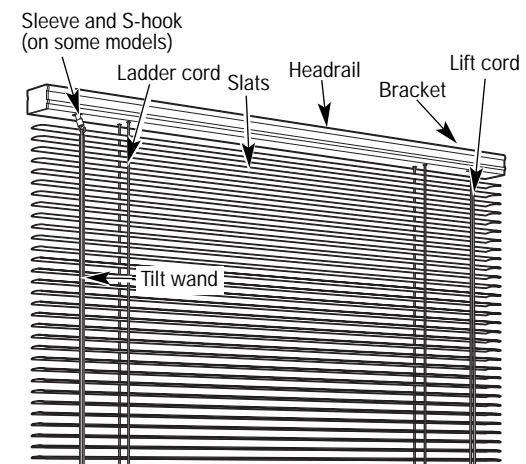

#### Tools and hardware you may need (not included)

The tools and hardware that you will need for installing your blinds will vary, depending on the installation surface and mounting bracket type. Tools typically used for installation include:

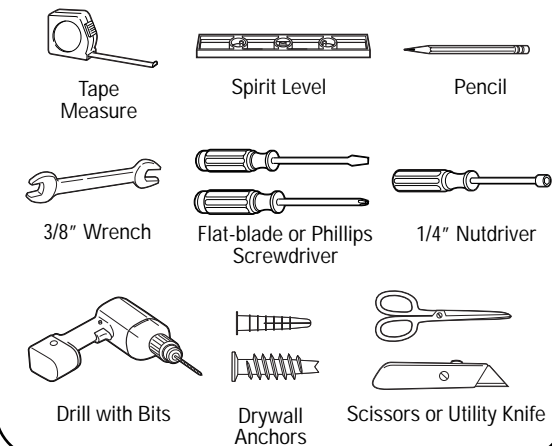

## 1 Mounting brackets

There are different types of mounting brackets, depending on the headrail size and style. However, all types shown below work in a similar manner.

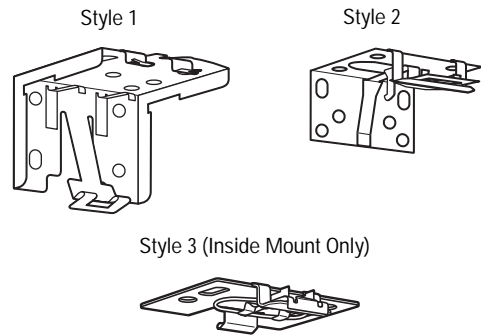

## 2 Optional extension brackets

If your blinds include optional extension brackets, temporarily assemble them to the mounting brackets at this time. You will need to use the extension brackets to determine mounting hole locations in Steps 3 and 4.

Refer to the included instructions for your style of extension brackets.

## 3 Mark the bracket locations

- Position one bracket as close as possible to each end of the headrail, making sure the brackets will not interfere with the cord mechanism or other internal headrail parts.
- When using a single center support bracket, center it between the ends. For more than one center support bracket, space the support brackets evenly, not more than 30" apart. Making sure the brackets will not interfere with the cord mechanism or any other internal parts.
- Using the included template as a guide, mark the bracket mounting hole locations, making sure they are square and equally spaced. For outside mount installations, use a spirit level to check for levelness.

### Outside mount

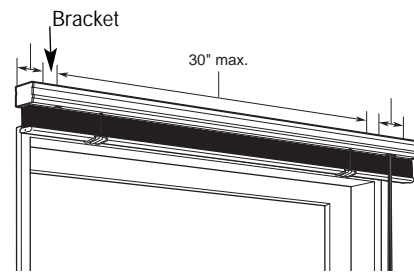

### Inside mount

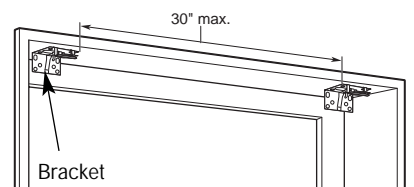

## 4 Optional bracket shims for inside mount

To properly engage the headrail on inside mount installations, some bracket styles require up to 1/4" between the headrail locking tabs and the mounting surface. If needed, use the included shims to ensure the necessary spacing.

- Separate the shims.
- Align the shim(s) and mark with the mounting holes used for marking bracket locations in Step 3.
- Drill through-holes at the marked locations.

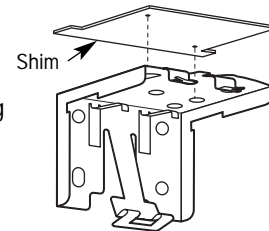

## 5A Install the brackets—outside-mount installation

If mounting into drywall or plaster, use 3/16" drill bit and insert wall anchors before inserting screws. Use two screws per bracket.

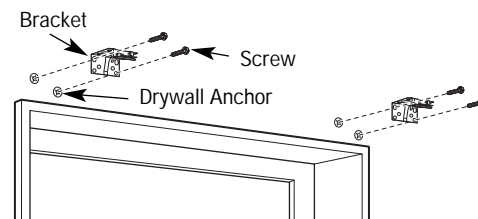

## 5B Install the brackets—inside-mount installation

Example: Installation in a wood window frame using the included screws. Use two screws per bracket.

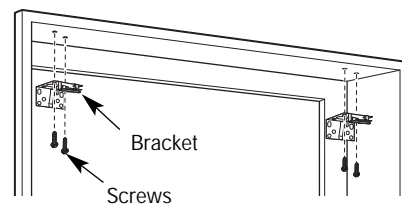

## 6 Attaching the head rail to the mounting brackets

### Style 1

- Fit the front lip of the headrail over the hook on the front of the bracket.
- Roll the back of the headrail up until the back clips of the bracket lock into place with a "click." Be careful not to clip the top slat when attaching the headrail to the mounting brackets.

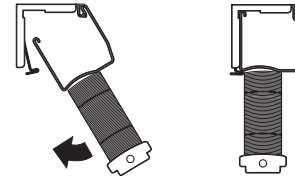

### Style 2

- Fit the front lip of the headrail over the hook on the front of the bracket.
- Pressing back on the headrail, roll the back of the headrail up until the back clips of the bracket lock into place with a "click."

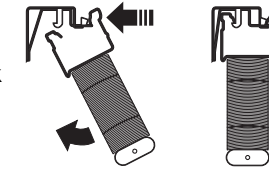

### Style 3

- Fit the front lip of the headrail over the spring-loaded ledge on the front of the bracket.
- Pressing back on the headrail, roll the back of the headrail up until the back lip of the headrail catches on the back lip of the bracket.

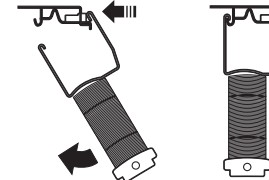

## 7 Attach the tilt wand

- Remove the protective rubber cap from the tilt mechanism on the headrail.
- **For models with a tilter stem (A):**
  - Slide the wand sleeve onto the tilter stem and fit the flat end of the S-hook into the tilter stem.
  - Hook the end of the tilt wand onto the S-hook and pull down the sleeve on the tilt mechanism.
- **For models with a tilter loop (B):**
  - Clip the end of the wand onto the tilter loop.
  - Rotate the tilt wand in each direction to ensure proper operation.

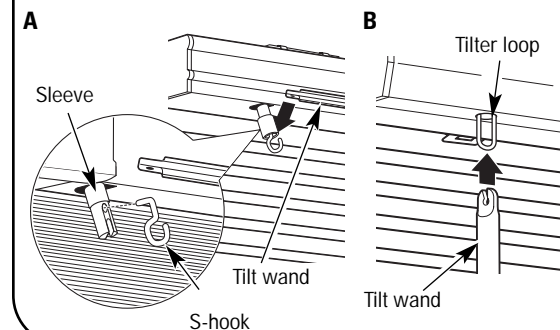

## 8 Attach optional hold-down brackets (on some styles)

### Type 1 – One-Piece Hold-Down Brackets

- With the hold-down brackets attached to the bottom rail, lower the blinds to the hold-down bracket mounting surface and mark the bracket locations.
- Attach the hold-down brackets at the bottom of the window with the included screws, as shown for your installation type.
- To attach the bottom rail, gently pull the brackets out slightly and insert the pins into the holes on the bottom rail of the blinds.

### Outside mount

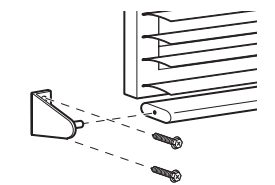

### Inside mount

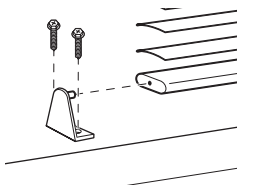

### Type 2 – Two-Piece Hold-Down Brackets

- Press the rounded end of the hold-down pins into the hole at each end of the bottom rail. The other end will hook into the hold-down brackets.
- **NOTE:** Some styles may have the hold-down pins built into the bottom rail.
- With the hold-down brackets attached to the bottom rail, lower the blinds to the hold-down bracket mounting surface and mark the location of the bracket.
- Attach the hold-down brackets at the bottom of the window with the included screws, as shown.
- Clip the bottom rail hold-down pins into the brackets.

### Inside mount

