

Installation Instructions for Wood Blinds

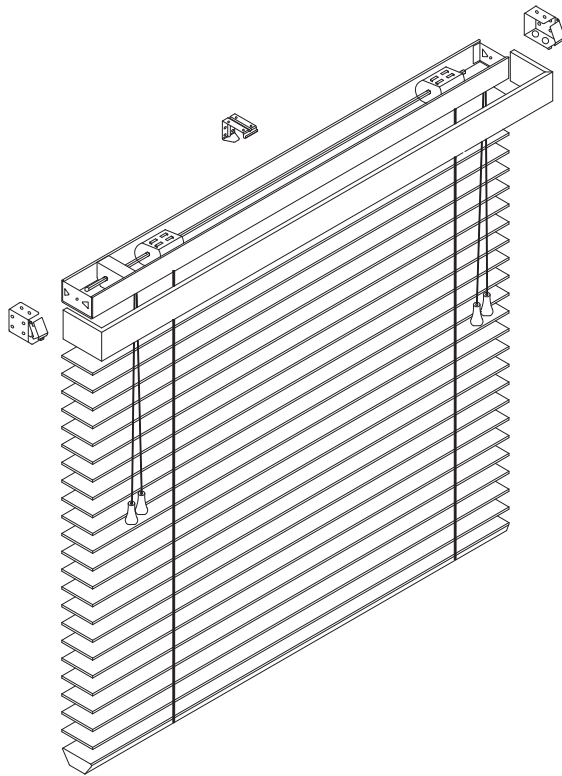

Thank you for purchasing our blinds. Your new blinds have been custom made to your specifications from the finest materials available.

Getting Started

Before you begin your installation, please read all the instructions.

- Remove the blind from the package and keep the packaging until the blind is installed and operates to your satisfaction.
- Do not lower the blind yet.
- Double check the head rail for proper width. If you are installing several blinds, be sure to match them with the appropriate window

Tools and Fasteners you may need (not included)

- Measuring tape and pencil
- Power drill with a 3/32" drill bit.
- Screwdriver and 1/4" nut driver
- Drywall anchors (not provided)
- Level

Installation Overview

1. The included brackets are attached to the wall with screws and drywall anchors when mounting into drywall
2. The blind is inserted or attached to the brackets. No tools necessary
3. The Valance is attached to the headrail

There are two type of mounting:

- **Inside Mount** – Blind fits within window opening
- **Outside Mount** – Blind mounts outside, overlapping window opening

There are two type of brackets

- **Box Brackets** – Two box brackets are used to mount a blind. Bracket appearance may vary depending on blind size. They are marked LH (Left hand) and RH (Right Hand)

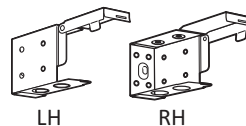

- **Center Support Bracket** - Wider blinds require one or more brackets to support the blind, provided if needed.

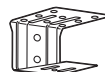

1. Inside Mount

Attach the two Box Brackets flush with the window frame, against the sides of the window casement . Screw into the window frame with two screws. For blinds with 2 1/2" slats, spacer blocks (included) are used to position the brackets a minimum of 3/8" from the glass. This prevents the slats from rubbing the glass when tilted.

Important: Use drywall anchors when mounting on drywall (not supplied).

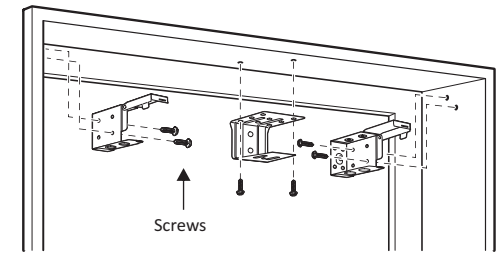

If Center support Brackets are included, evenly space them between the two end brackets. Be sure they are positioned in a way they do not interfere with the blind operation.

Continue to 3. Attach Valance Clips

2. Outside Mount

Center the blind over the window opening, at the desired height. Hold the blind in the desired position and mark 1/4" to the outside of the headrail ends. These marks are where the outside edges of the end brackets will be located. Use the level to be sure the blind is leveled. If Center support Brackets are included, evenly space them between the two end brackets. Be sure they are positioned in a way they do not interfere with the blind operation and they are leveled.

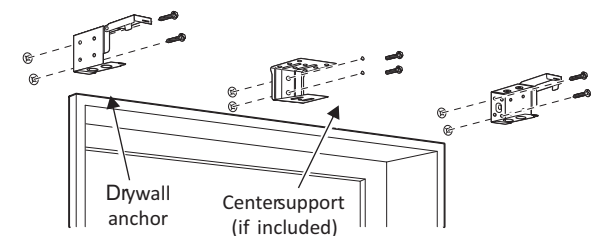

3. Attach Valance Clips

Snap the plastic Valance Clips on the head rail as shown. Make sure the clips are in alignment with the mounting strips on the back of the valance.

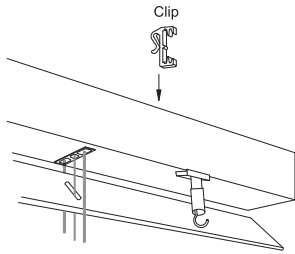

4. Insert Blind into Mounting Brackets

Open the bracket doors. Tilt the headrail so that its back lip slides under the front lip of the end brackets and center support brackets. Slide headrail against the back of the brackets. Close doors and press until the locking tab clicks into place.

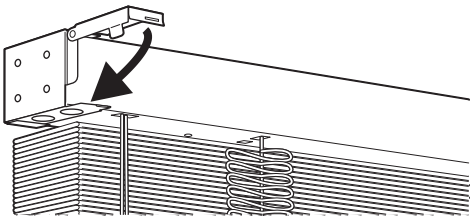
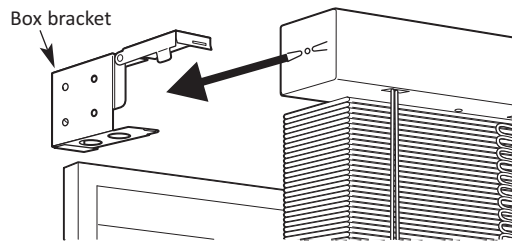

5. Complete the Installation

If the blind was ordered with a Wand Tilter, attach the wand to the metal hook, sliding the plastic sleeve up. Pull the sleeve down to keep the wand in place.

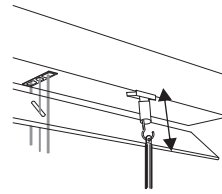

5.1 Attach the Valance

Center the valance on the headrail and snap the valance into the plastic valance clips starting from the center of blind. For outside mounts, if the side returns are too long, they can be trimmed to size with a fine tooth saw.

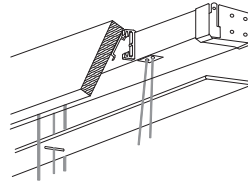

5.2 Attach Optional Hold-Down Brackets

If you ordered Hold Down brackets to secure the bottom rail of the blind, place the hold down pins in the bottom rail end holes. Lower bottom rail and close slats. Attach the hold down brackets at the bottom of the window with the included screws, as shown

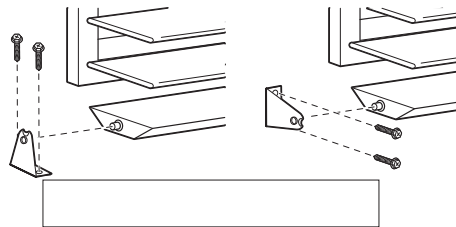

6. Operate the Blind

- **Tilting the slats** – With Wand tilt, rotate the wand to tilt the slats the desired angle. With Cord Tilt, the two cords with individual tassels are for tilting the slats. Each cord tilts the slats in alternate direction

- **Raising and Lowering the Blind** – To raise or lower the blind, the slats must be in the open (horizontal) position. Pull the cord toward the center of the blind and down to release the cord lock. When the cord is at the desired position, return the cord to the original position to engage the cord lock.